

Panasonic®

■ This product is eligible for the P2HD 5 Year Warranty Repair Program. For details, see page 5.

Operating Instructions/Bedienungsanleitung Mode d'emploi/Istruzioni per l'uso Instrucciones de funcionamiento

Memory Card Camera-Recorder/Speicherkarten-Kamerarecorder
Caméscope à carte mémoire/Camcorder a schede di memoria
Camascopio basado en tarjeta de memoria

Model No. **AG-HPX171E**

P2HD

DVCPRO HD

DVCPRO 50

DVCPRO

DV

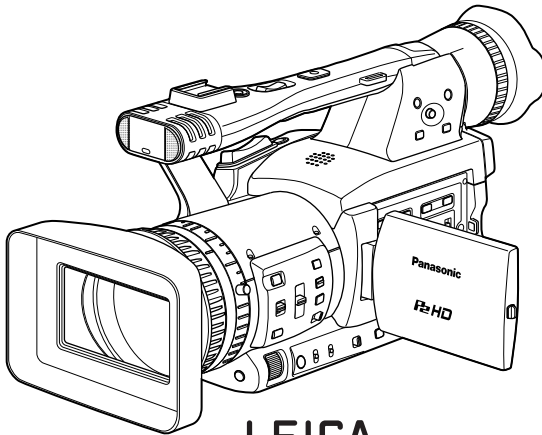

**LEICA
DICOMAR**



**S-Log
HD**

Before operating this product, please read the instructions carefully and save this manual for future use. Lesen Sie die Anweisungen vor der Verwendung dieses Produkts sorgfältig durch, und bewahren Sie das vorliegende Handbuch zur künftigen Referenz auf.

Avant d'utiliser ce produit, veiller à lire attentivement ce manuel et le conserver pour un usage ultérieur. Prima di utilizzare questo prodotto, leggere queste istruzioni e conservare questo manuale per consultarlo quando necessario.

Antes de utilizar este producto, lea estas instrucciones de funcionamiento con atención y guárdelas para poder consultarlas en el futuro.

Before use

Description of parts

Preparation

Shooting

Playback

Editing

Displays

Menu

Reference

Read this first!

 indicates safety information.

Caution for AC Mains Lead

FOR YOUR SAFETY PLEASE READ THE FOLLOWING TEXT CAREFULLY.

This product is equipped with 2 types of AC mains cable. One is for continental Europe, etc. and the other one is only for U.K.

Appropriate mains cable must be used in each local area, since the other type of mains cable is not suitable.

FOR CONTINENTAL EUROPE, ETC.
Not to be used in the U.K.

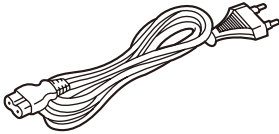

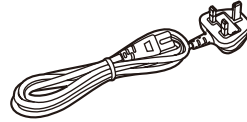

FOR U.K. ONLY



FOR U.K. ONLY

This appliance is supplied with a moulded three pin mains plug for your safety and convenience.

A 5 amp fuse is fitted in this plug. Should the fuse need to be replaced please ensure that the replacement fuse has a rating of 5 amps and that it is approved by ASTA or BSI to BS1362.

Check for the ASTA mark  or the BSI mark  on the body of the fuse.

If the plug contains a removable fuse cover you must ensure that it is refitted when the fuse is replaced.

If you lose the fuse cover the plug must not be used until a replacement cover is obtained.

A replacement fuse cover can be purchased from your local Panasonic Dealer.

How to replace the fuse

1. Open the fuse compartment with a screwdriver.

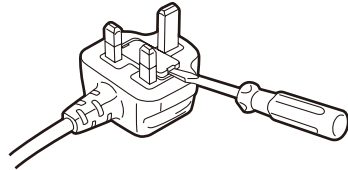

2. Replace the fuse

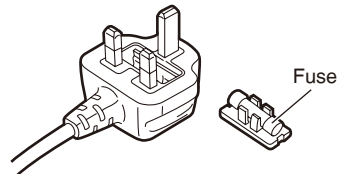

 indicates safety information.

■ DO NOT REMOVE PANEL COVERS BY UNSCREWING THEM.

To reduce the risk of electric shock, do not remove cover. No user serviceable parts inside. Refer servicing to qualified service personnel.

WARNING:

- TO REDUCE THE RISK OF FIRE OR SHOCK HAZARD, DO NOT EXPOSE THIS EQUIPMENT TO RAIN OR MOISTURE.
- TO REDUCE THE RISK OF FIRE OR SHOCK HAZARD, KEEP THIS EQUIPMENT AWAY FROM ALL LIQUIDS. USE AND STORE ONLY IN LOCATIONS WHICH ARE NOT EXPOSED TO THE RISK OF DRIPPING OR SPLASHING LIQUIDS, AND DO NOT PLACE ANY LIQUID CONTAINERS ON TOP OF THE EQUIPMENT.

WARNING:

Always keep memory cards or accessories (coin battery, microphone holder screws, microphone holder adapter, ferrite cores, INPUT terminal cover) out of the reach of babies and small children.

CAUTION:

TO REDUCE THE RISK OF FIRE OR SHOCK HAZARD AND ANNOYING INTERFERENCE, USE THE RECOMMENDED ACCESSORIES ONLY.

CAUTION:

In order to maintain adequate ventilation, do not install or place this unit in a bookcase, built-in cabinet or any other confined space. To prevent risk of electric shock or fire hazard due to overheating, ensure that curtains and any other materials do not obstruct the ventilation.

CAUTION:

Do not lift the unit by its handle while the tripod is attached. When the tripod is attached, its weight will also affect the unit's handle, possibly causing the handle to break and hurting the user. To carry the unit while the tripod is attached, take hold of the tripod.

CAUTION:

Danger of explosion or fire if battery is mistreated.

For Battery Pack

- Replace only with same or specified type.
- Do not disassemble or dispose of in fire.
- Do not store in temperatures over 60°C (140°F).
- Do not leave the battery in an automobile exposed to direct sunlight for a long period of time with doors and windows closed.
- Use specified charger.

For Battery of Remote Controller

- Replace battery with part No. CR2025 only.
- Do not recharge the battery.
- Do not disassemble or dispose of in fire.
- Do not store in temperatures over 60°C (140°F).

Camera-Recorder

The rating plate is on the underside of the viewfinder.

AC Adapter

The rating plate is on the underside of the AC Adapter.

Disconnect the AC mains plug from the AC mains socket when not in use.

CAUTION:

THE MAINS PLUG OF THE POWER SUPPLY CORD SHALL REMAIN READILY OPERABLE. THE AC RECEPTACLE (MAINS SOCKET OUTLET) SHALL BE INSTALLED NEAR THE EQUIPMENT AND SHALL BE EASILY ACCESSIBLE.

TO COMPLETELY DISCONNECT THIS EQUIPMENT FROM THE AC MAINS, DISCONNECT THE POWER CORD PLUG FROM THE AC RECEPTACLE.

CAUTION:

Do not jar, swing, or shake the unit by its handle while the conversion lens or another accessory is attached.

Due to the added weight of the conversion lens, any strong jolt to the handle may damage the unit or result in personal injury.

CAUTION:

EXCESSIVE SOUND PRESSURE FROM EARPHONES AND HEADPHONES CAN CAUSE HEARING LOSS.

CAUTION:

Do not leave the unit in direct contact with the skin for long periods of time when in use. Low temperature burn injuries may be suffered if the high temperature parts of this unit are in direct contact with the skin for long periods of time.

When using the equipment for long periods of time, make use of the tripod.

Operating precaution

Operation near any appliance which generates strong magnetic fields may give rise to noise in the video and audio signals. If this should be the case, deal with the situation by, for instance, moving the source of the magnetic fields away from the unit before operation.

IMPORTANT

“Unauthorized recording of copyrighted television programs, video tapes and other materials may infringe the right of copyright owners and be contrary to copyright laws.”

Recommendation for Use of Genuine Panasonic Battery Pack (Rechargeable Battery)

Thank you for using a Panasonic product.

It has been our policy to recommend that the genuine Panasonic battery pack be used for any Panasonic product that uses a battery pack, including digital cameras. It has, however, been found that imitation battery packs that look very similar to the genuine Panasonic battery pack are marketed in some markets.

Some of these imitation battery packs are not equipped with any protective devices that meet given quality standards for permitting use at high power outputs and for long hours.

If any of these battery packs of inferior quality is used, it could lead to an accident or failure involving firing or explosion.

To ensure that our products are used in utmost safety, we once again remind you that we recommend the use of a genuine Panasonic battery pack for any Panasonic product that is to use a battery pack. The genuine Panasonic battery packs are sold under our stringent quality control.

Please be advised that we are not liable for any accident or failure occurring as a result of use of an imitation battery pack.

We appreciate your kind understanding and cooperation in this regard.

Software information for this product

1. Customer advisory: This product includes software licensed under the GNU General Public License (GPL) and GNU Lesser General Public License (LGPL); customers have the right to download, modify, and redistribute source code for this software.
Descriptions of the GPL and LGPL are stored on the installation CD included with this camera-recorder. See the folder named \LDOC. (The description is the original (written in English).) To download the relevant source code, visit <https://www.pavc.panasonic.co.jp/pro-av/>
Please note that we cannot answer any questions you may have about the content, etc. of any source code you may obtain from the above Web site.
2. This product includes software licensed under the MIT License. A description of the MIT is stored on the installation CD included with this camera-recorder. See the folder named \LDOC. (The description is the original (written in English).)

- LEICA is a trademark of Leica Microsystems IRGmbH.
- DICOMAR is a trademark of Leica Camera AG.
- SD logo is a trademark.

All other explanations, company names, and product names are the registered trademarks of the respective companies.



To remove the battery

Main Power Battery (Refer to page 16 for the detail.)

Press the battery removal button.

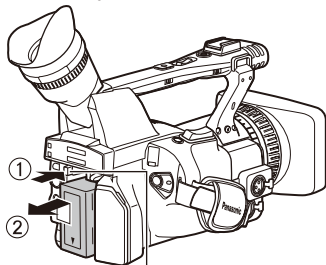

Battery removal button

Remote Control Battery

- ① While pressing the stopper **A**, pull out the battery holder.

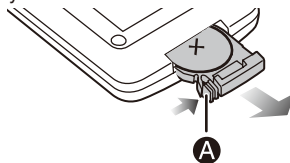

- ② Remove the button-type battery from the battery holder.

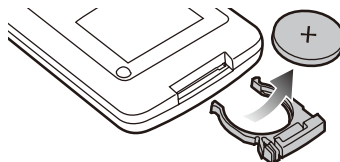

P2HD 5 Year Warranty Repair Program^{*1}

Thank you for purchasing this Panasonic P2HD device.

Register as a user for this device to receive a special service warranty up to five years of free warranty repairs.

Customers who register as users on the website will receive a extended warranty repair valid for up to five years.

	1st year	2nd year	3rd year	4th year	5th year ^{*5}
P2HD device ^{*2}	Basic warranty ^{*3}	Extended warranty repair ^{*4}			

^{*1}: Please note that this extended warranty is not available in some countries/regions see web site below for details. ^{*2}: Not all models eligible for extended warranty coverage. ^{*3}: The basic warranty period may vary depending on the country/region see enclosed warranty for warranty coverage. ^{*4}: Not all repair work is covered by this extended warranty see enclosed warranty card for warranty coverage. ^{*5}: The maximum warranty period may be adjusted depending on the number of hours the device has been used.



Purchase
P2 product



Register online
within 1 month



"Registration Notice"
e-mail sent

Free 5 years of Warranty Repairs

Make sure to save the "Registration Notice"
e-mail during the warranty period.

Details about user registration and the extended warranty: http://panasonic.biz/sav/pass_e

Contents

Read this first!	2
Operating precaution	4
IMPORTANT.....	4
Recommendation for Use of Genuine Panasonic Battery Pack (Rechargeable Battery)	4
Software information for this product	4
To remove the battery	5
Main Power Battery	5
Remote Control Battery	5

Before use

Outline of operations	8
Precaution for use	9
Accessories	10
Optional units	10
About this manual	10

Description of parts

Description of parts	11
Right side and rear side	11
Left side	12
Terminals and mounting parts	13
Remote control	14

Preparation

The battery	15
Charging	15
Installing and removing the power supply	16
Installing and removing the battery	16
Connecting and disconnecting the power cord.....	16
Adjusting the hand strap	17
Attaching the shoulder strap.....	17
Detaching and attaching the lens hood	17
The remote control	18
Insert the battery	18
Remote control setup	18
Turn on/off the camera	19
Tally lamp	19
Viewfinder	20
Using the viewfinder	20
Using the LCD	21
Emphasizing outlines	21
Adjusting the screen display.....	22
Adjusting the backlight.....	23
Flipping images vertically and horizontally	23
Switching between overscan and underscan.....	23
Setting the calendar	24

Shooting

Basic shooting operations	25
---------------------------------	----

Preparing to shoot	25
Shooting in auto mode	25
Checking photos taken (REC CHECK)	26
P2 card access lamps	26
Protecting against a possible erasure	26
Formatting P2 cards	26
Recording times	27
Remove the P2 card	28
Using SD/SDHC memory cards.....	29
Installing and removing the SD memory card	29
Formatting SD memory card	29
Cautions in using SD memory cards.....	29
Using the zoom function.....	30
Digital zoom function	30
Variable frame rates (VFR).....	31
Native recording	33
Standard recording.....	33
Using variable frame rates (VFR)	34
Shooting in 1080i/576i (480i) progressive mode.....	35
Shooting in 1080i/576i progressive mode	35
Shooting in 1080i/480i progressive mode	35
Shooting in manual mode.....	36
Switching to manual mode	36
Manual focusing	36
Using focus assist.....	37
Iris adjustments	37
Adjusting the gain	38
Light intensity adjustments	38
Adjusting the white balance.....	39
Black balance adjustments.....	40
Auto Tracking White (ATW)	40
Shooting techniques for different targets	41
Low-angle shooting	41
Self-portrait shooting	41
Zebra pattern.....	41
Marker	41
Checking and displaying shooting status	42
Changing the image size	42
Optical Image Stabilizer.....	43
Adding effects to images	43
Using the USER buttons.....	43
Backlight compensation.....	43
Color bars.....	43
Waveform monitor function.....	44
Adjusting the volume while shooting	44
Backup recording.....	44
2-slot continuous recording	45
Shot mark function	45
Text memo recording	45
Time stamp function	45
LAST CLIP DELETE function	46
Using the special recording functions	47

Pre-recording (PRE REC)	47	Headphones	77
Interval recording (INTERVAL REC).....	47	External microphone	77
One-shot recording (ONE-SHOT REC).....	48	Computer (non-linear editing/file transfer)	78
Loop recording (LOOP REC)	48	Hard disk drive (data copying)	79
Adjusting the shutter speed	50	Digital video equipment (Dubbing)	80
Synchro scan.....	51	Video deck (Dubbing)	81
Switching Audio Input.....	52	TV/Monitor (playback/dubbing).....	81
Using the built-in microphone	52	Nonlinear editing with P2 card (PC mode)	82
Using another microphone and audio equipment.....	52	Copying from P2 cards to the hard disk drive (1394 HOST mode).....	84
Adjusting the recording level	53	Warnings	86
Using scene files	54	Dubbing	87
Changing scene file settings	54	Digital input/output.....	87
Saving scene files and other settings on SD memory cards	56	Analog output	87
Clip metadata	58	Displays	
Using the Counter	59	Screen displays	88
Counter display.....	59	Regular displays	88
1394TC preset mode.....	59	Warnings	92
Charging the built-in battery/ Setting the time data	60	Setting the DISPLAY items.....	94
Recharging the built-in battery	60	Menu	
Setting the time code.....	60	Using the setup menus	95
Specifying the time code (TC PRESET).....	60	Using the menus.....	95
Setting user information.....	62	Initializing the menu settings	96
Playback		Setup menu structure	97
Basic playback operations	64	CAM (camera) mode menu	97
Thumbnail screen.....	65	MCR (playback) mode menu	98
Basic thumbnail screen operations.....	65	Setup menu list.....	99
Adding shot marks to clips	67	SCENE FILE screen.....	99
Clearing the thumbnail screen.....	67	CAMERA SETUP screen	101
Direct shooting functions	67	SW MODE screen	102
Thumbnail operations	68	AUTO SW screen	104
Selecting the thumbnail display method (THUMBNAIL)	68	RECORDING SETUP screen.....	105
Deleting clips and formatting cards (OPERATION)	69	PLAYBACK FUNCTIONS screen	108
Checking the clip or card information (PROPERTY)	70	AV IN/OUT SETUP screen.....	108
Editing the recorded clip metadata	72	DISPLAY SETUP screen.....	109
Uploading the metadata (META DATA).....	73	CARD FUNCTIONS screen.....	111
Useful playback functions	75	OTHER FUNCTIONS screen	111
Variable speed search.....	75	OPTION MENU screen	114
Slow playback.....	75	Reference	
Fast forward/rewind playback	75	Before calling for service.....	115
Frame-by-frame playback.....	75	Operating precautions	118
Clip skip	76	Updating the driver in the camera	120
Adjusting the volume	76	Cleaning	121
Viewing images on a monitor	76	Storage Precautions.....	122
Checking the date and time.....	76	How to handle data recorded on P2 cards....	123
		Checkpoints for using memory cards	124
		Recording format list.....	125
		Appendix	126
		Specifications	127
Editing			
Connecting external units	77		

Outline of operations

This unit is compatible with P2 (Professional Plug-in) cards.

The P2 card has a large capacity with a high transfer rate, and allows you sophisticated movie-making on this handy camera, including HD (High Definition) recording and smooth editing/dubbing.

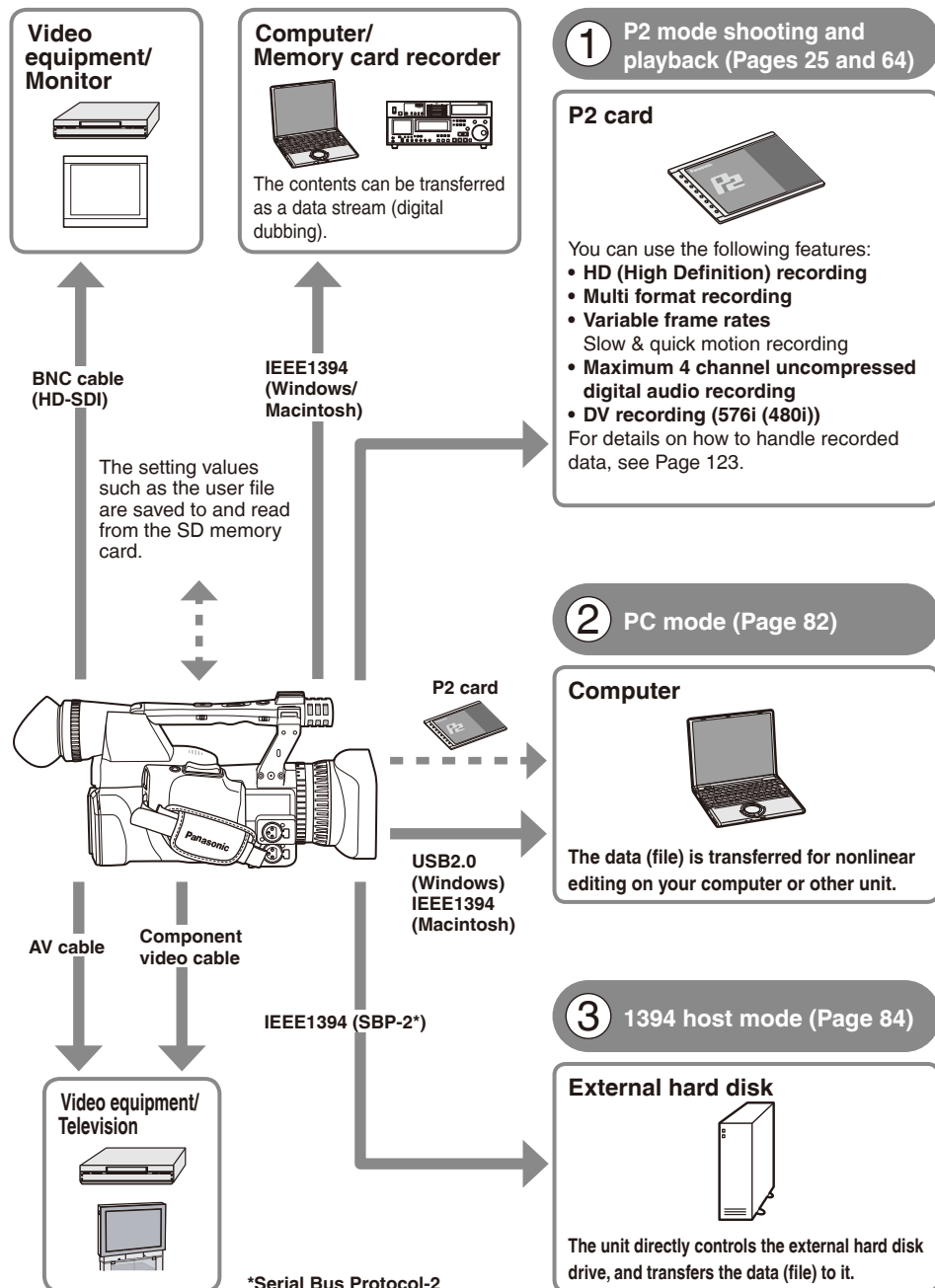

Precaution for use

Always take some trial shots before actual shooting.

- When shooting important events (such as weddings), always take some trial shots and check that the sound and images have been recorded properly before actual shooting.

Be sure to check and set the calendar and time zone.

- These settings affect the control and playback sequence of the recorded contents. Before making a recording, set and check the calendar and time zone. (Page 24)

Panasonic makes no guarantees for your recordings.

- Please understand that Panasonic makes no guarantees for your recordings in cases where images and/or sound were not recorded as you intended due to problems with the camera-recorder.

Respect copyrights

- Copyright laws forbid the use of video and audio material you have recorded for any purpose other than your own personal enjoyment. Remember that restrictions apply to the shooting of certain material even if it is intended for private use.

Caution regarding laser beams

- The CCD may be damaged if it is subjected to light from a laser beam.
When using the camera-recorder in locations where laser irradiation equipment is used, be careful not to allow the laser beam to shine directly on the lens.

Notes when connecting a 1394 cable

- Windows:
Before connecting, turn off the main unit power, and check the shape and orientation of the terminal.
- Macintosh:
After turning on the power of the Apple Macintosh computer, check the shape and orientation of the terminal, and then connect the cable.
(Pages 78, 79)

Media that can be used in this unit

The following media can be used in this unit. For details, refer to the respective pages.

- P2 card (Pages 25, 123)
- SD/SDHC memory cards (Pages 29, 124)

Mounting the camera-recorder on a tripod



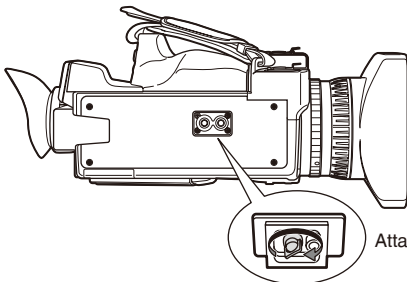







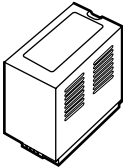
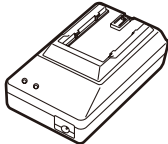
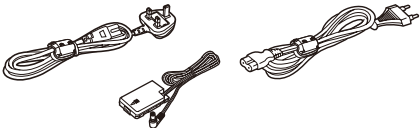

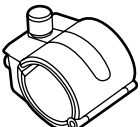

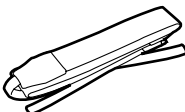
The tripod mounting hole is 5.5 mm deep. Do not force the tripod screw beyond this depth. You can damage the camera-recorder if you use any screw other than 1/4-20UNC.

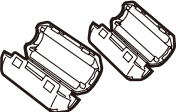

Attach the tripod to the tripod hole.

For other usage notes, see Page 118.

Accessories

<p>Battery *1</p> 	<p>AC Adapter</p> 	<p>AC power supply cords/DC cord (For the U.K.) (For areas other than the U.K.)</p> 			
<p>Eye cup</p> 	<p>Microphone holder</p> 	<p>Screws for microphone holder 6-mm screws (2) 12-mm screws (2)</p> 	<p>Microphone holder adapter</p> 		
<p>Shoulder belt</p> 	<p>Component video cable</p> 	<p>PIN-BNC conversion plugs (3)</p> 	<p>30-mm ferrite core (2)*2 35-mm ferrite core (2)*2</p> 		
<p>CD-ROM</p> 	<p>Wireless remote control and battery (CR2025)</p> 	<p>The following accessories are attached to the camera-recorder.</p> <table border="1" data-bbox="552 837 1009 959"> <tr> <td data-bbox="552 837 781 959"> <p>Lens hood</p>  </td> <td data-bbox="787 837 1009 959"> <p>INPUT terminal cover (2)</p>  </td> </tr> </table>		<p>Lens hood</p> 	<p>INPUT terminal cover (2)</p> 
<p>Lens hood</p> 	<p>INPUT terminal cover (2)</p> 				

*1 For part numbers for the battery, see "Optional units". (see below)

*2 When using a 1394 cable (sold separately) or a USB cable (sold separately), attach ferrite cores to the both ends of the cable. (Page 78)

Optional units

- **XLR microphone**
AG-MC200G
- **Battery**
CGA-D54 (5400 mAh: equivalent to accessory battery)

About this manual

Note concerning illustrations in these instructions

- Illustrations (camera-recorder, menu screens, etc.) in these operating instructions differ slightly from the actual camera-recorder.

References

- References are shown as (Page @).

Description of parts

Right side and rear side

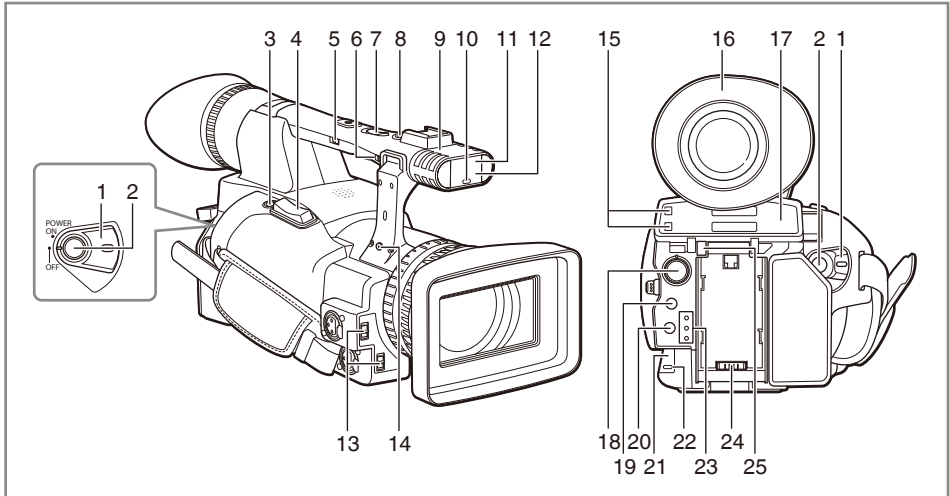

- | | |
|--|--|
| 1 POWER switch (Page 19) | 13 INPUT 1/2 (audio input) switch (Page 52) |
| 2 START/STOP button (Page 25) | 14 Zoom ring pin hole (Page 30) |
| 3 REC CHECK button (Page 25) | 15 P2 card access lamp (x 2) (Page 26) |
| 4 Zoom button (Page 30) | 16 Viewfinder (Page 20) |
| 5 HANDLE ZOOM switch (Page 30) | 17 P2 card/SD memory card slot (cover)
(Pages 25 and 29) |
| 6 Recording enable/disable switch (Page 41) | 18 SCENE FILE dial (Page 54) |
| 7 Handle zoom button (Page 30) | 19 SLOT SEL button (Page 45) |
| 8 Handle START/STOP button (Page 25) | 20 Mode button (Page 25) |
| 9 Built-in stereo microphone (Page 52) | 21 Remote control sensor (Rear) (Page 18) |
| 10 Tally lamp (Front) (Page 19) | 22 Tally lamp (Rear) (Page 19) |
| 11 Remote control sensor (Front) (Page 18) | 23 Mode lamp (Page 25) |
| 12 White balance sensor (Page 40) | 24 Power terminal (Page 16) |
| | 25 Battery release button (Page 16) |

Description of parts (continued)

Left side

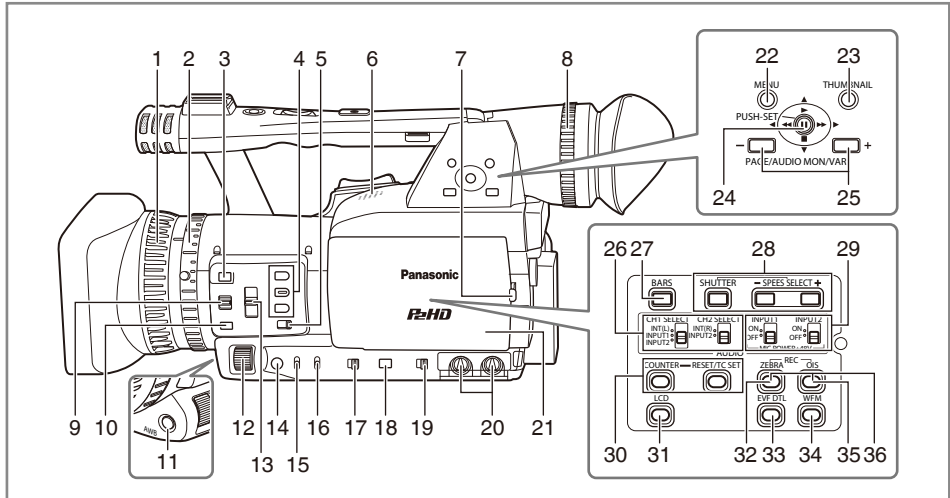

- | | |
|---|---|
| <p>1 Focus ring (Page 36)</p> <p>2 Zoom ring (Page 30)
If you don't need the zoom ring pin, fit it into the provided zoom ring pin hole (14 on page 11) so that you don't lose it.</p> <p>3 FOCUS ASSIST button (Page 37)</p> <p>4 USER button (Page 43)</p> <p>5 ZOOM switch (Page 30)</p> <p>6 Built-in speaker (Page 76)</p> <p>7 OPEN button (Page 21)</p> <p>8 Diopter adjustment dial (Page 20)</p> <p>9 FOCUS switch (Page 36)</p> <p>10 PUSH AUTO button (Page 36)</p> <p>11 AWB button (Page 39)</p> <p>12 IRIS dial (Page 37)</p> <p>13 ND FILTER switch (Page 38)</p> <p>14 IRIS button (Page 37)</p> <p>15 GAIN switch (Page 38)</p> <p>16 WHITE BAL switch (Page 39)</p> <p>17 FOCUS RING (FOCUS/IRIS) switch (Page 36)</p> <p>18 DISP/MODE CHK button (Page 42)</p> | <p>19 AUTO/MANUAL switch (Page 25)</p> <p>20 AUDIO LEVEL knobs (CH1, CH2) (Page 53)</p> <p>21 LCD monitor (Page 21)</p> <p>22 MENU button (Page 95)</p> <p>23 THUMB NAIL button (Page 67)</p> <p>24 Operation lever (Pages 64 and 95)</p> <p>25 PAGE/AUDIO MON/VAR button (Pages 44 and 75)</p> <p>26 CH1, CH2 SELECT switch (Page 52)</p> <p>27 BARS button (Page 43)</p> <p>28 SHUTTER, SPEED SELECT +/- button (Page 50)</p> <p>29 INPUT1, 2 switch (MIC POWER +48 V) (Page 52)</p> <p>30 COUNTER - RESET/TC SET button (Page 59)</p> <p>31 LCD button (Page 23)</p> <p>32 ZEBRA button (Page 41)</p> <p>33 EVF DTL button (Page 21)</p> <p>34 WFM button (Page 44)</p> <p>35 OIS button (Page 43)</p> <p>36 MCR REC button (Page 87)
Functions when the ZEBRA button (32) and OIS button (35) are pressed at the same time.</p> |
|---|---|

Terminals and mounting parts

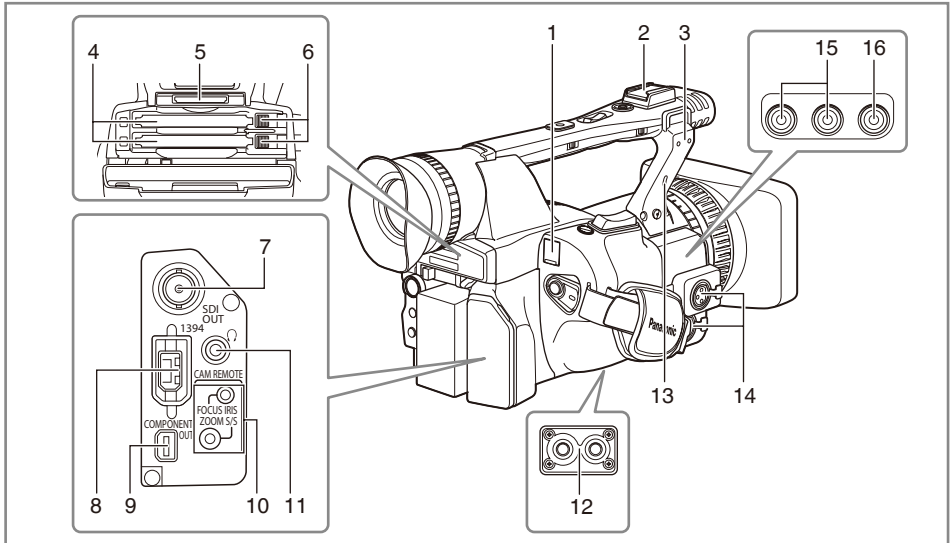

- 1 USB terminal (Mini-B)** (Page 78)
- 2 Light shoe**
- 3 Microphone shoe** (Page 77)
- 4 P2 card slots** (Page 25)
- 5 SD memory card slot** (Page 29)
- 6 P2 card eject buttons** (Page 28)
- 7 SDI OUT terminal** (Page 81)
- 8 1394 terminal** (Pages 78 and 79)
- 9 COMPONENT OUT terminal** (Page 81)
- 10 CAM REMOTE jack***
FOCUS/IRIS (3.5 mm mini jack)
 You can connect a remote control unit to control the FOCUS and IRIS (aperture).
ZOOM S/S (2.5 mm super mini jack)
 You can connect a remote control unit to control zoom and start/stop of recording.
- 11 Headphone jack (3.5 mm stereo mini jack)**
 (Page 77)
- 12 Tripod hole** (Page 9)
- 13 Security Lock opening**
 Use this opening to attach a security cable. For details on how to attach the cable, see the Operating Instructions supplied with the cable. The security lock and security cable are designed to prevent theft, but Panasonic will not accept any liability for damages resulting from theft.
- 14 INPUT 1/2 terminal (XLR, 3 pin)** (Page 77)
- 15 AUDIO OUT CH1/CH2 terminals** (Page 81)
- 16 VIDEO OUT terminal** (Page 81)

* Do not connect any equipment except the remote controller to the CAM REMOTE jack. Connecting any equipment other than the remote control may cause the image brightness to change and/or the images to appear out of focus.

Description of parts (continued)

Remote control

The following buttons are for functions that cannot be executed on the camera-recorder.

- PHOTO SHOT
- TITLE
- A.DUB
- MULTI/P-IN-P
- SELECT
- STORE
- OFF/ON
- PB.ZOOM
- INDEX

- 1 **DATE/TIME button** (Page 76)
- 2 **OSD button** (Page 76)
- 3 **COUNTER button** (Page 59)
Same function as the COUNTER button on the main unit.
- 4 **COUNTER RESET button** (Page 59)
Same function as the COUNTER RESET button on the main unit.
- 5 **REC button** (Page 87)

Operation buttons

- 6 **PLAY button** (▶) (Pages 64 and 87)
- 7 **REW button** (◀◀) (Page 64)
- 8 **PAUSE button** (||) (Page 64)
Like the operation buttons of the camera, MENU operations are performed using SET button.
- 9 **STILL ADV button** (◀|, |▶) (Page 18)
- 10 **STOP button** (■) (Page 64)
- 11 **FF button** (▶▶) (Page 64)

Buttons for shooting and volume control

- 12 **START/STOP button** (Page 25)
Same function as the START/STOP button on the main unit.
- 13 **ZOOM/VOL buttons** (Page 30)
- 14 **VAR. SEARCH button** (Page 75)
- 15 **MENU button** (Page 95)
Functions the same as the MENU button on the camera.

[◀], [▶], [▲], [▼] buttons

Function the same as the Operation lever on the camera.

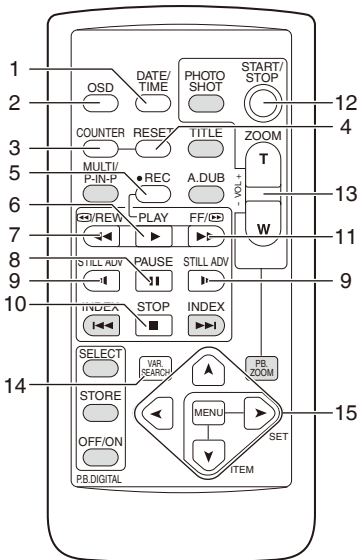

The battery

Charging

Before using the battery, fully charge it with the AC adapter.

Keep a spare battery with you.

1 Align the battery with the  marking on the AC adapter, place it flat, and slide it in the direction shown below.

- You cannot charge the battery if the DC cord is connected to the DC OUT connector, so disconnect it first.

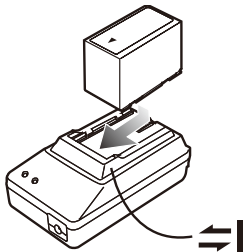

2 Plug the AC cord into the power outlet.

- The POWER lamp and CHARGE lamp on the AC adapter light, and charging begins.
- If the CHARGE lamp does not light when attached, detach the battery and then attach it again.

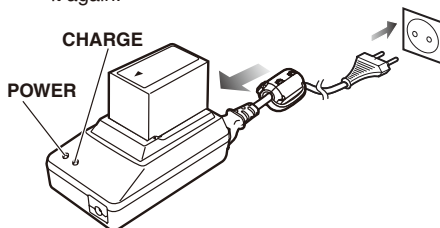

- When the battery is charged, the CHARGE lamp on the AC adapter goes out.

3 Slide the battery and remove it.

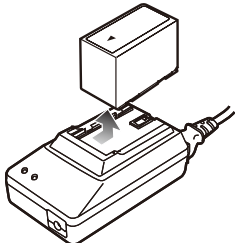

Recording time of included battery

Capacity	Recharging time	Continuous recording time
5400 mAh	Approx. 330 min.	Approx. 160 min.

- The times given above are approximate for when scenes are shot in the DVCPRO HD mode while not using the LCD monitor.
- The times apply when the ambient operating temperature is 20°C and humidity is 60%. Charging may take longer at other temperatures and humidity levels.

• **Keep metal objects (such as necklaces and hairpins) away from the battery. Shortcircuiting may occur across the terminals, causing the battery to heat up, and you may seriously burn yourself if you touch the battery in this state.**

- The battery becomes hot while it is being used or charged. The camera-recorder itself also becomes hot during use.
- The recordable time reduces if you repeatedly start and stop recording.
- Discharge the battery before storing it. When storing it for an extended time, charge it at least once a year, use up its charge in the camerarecorder, and then store it again.
- If the battery is extremely hot or cold, the CHARGE lamp will blink several times before charging starts.
- If the CHARGE lamp continues to blink even when the battery temperature is normal, there may be something wrong with the battery or AC adapter. Contact your dealer.
- The battery takes longer to charge when it is warm.
- The AC adapter can interfere with radio reception so keep radios at least 1 meter away from it.
- The AC adapter may make some noise when you are using it, but this is normal.
- You cannot charge the battery when supplying power to the camera-recorder from the AC adapter.
- Operation of battery pack CGR-D16 (1600 mAh) (sold separately) is not guaranteed.

Installing and removing the power supply

Installing and removing the battery

Installation

- 1 Insert the battery until it clicks into place.

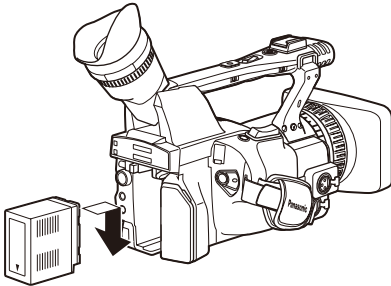

Removal

- 1 Set the POWER switch to OFF, and check that the mode lamp is off.
- 2 While pressing the battery release button, raise up the battery to remove it.
 - Support the battery with your hand to ensure that it will not fall.

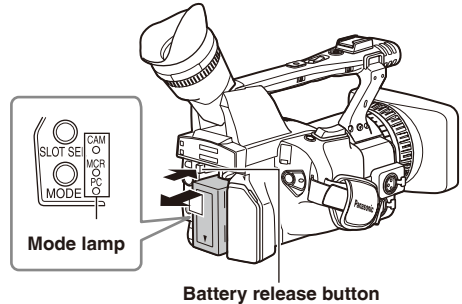

Connecting and disconnecting the power cord

Installation

- 1 Connect the DC cord to the AC adapter.
- 2 Plug the AC power supply cord into the power outlet.
- 3 Slide the DC cord's battery connector to the direction of the arrow until it clicks into place.

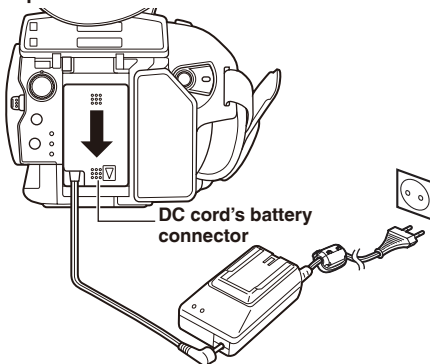

Removal

- 1 Set the POWER switch to OFF, and check that the mode lamp is off.
- 2 Slide the DC cord's battery connector to the direction of the arrow while pressing the battery release button.

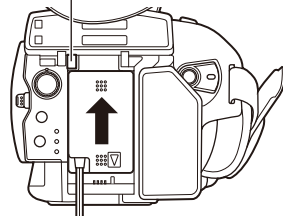

- 3 Disconnect the AC power supply cord from the power outlet.

CAUTION:

- You cannot charge the battery when supplying power to the camera-recorder from the AC adapter.
- Disconnect the AC power supply cord from the power outlet when the unit is not going to be used.

Adjusting the hand strap

Adjust the hand strap to suit your hand.

- 1 Open the cover and adjust the length.
- 2 Close the cover.
 - Make sure the cover is fully closed.

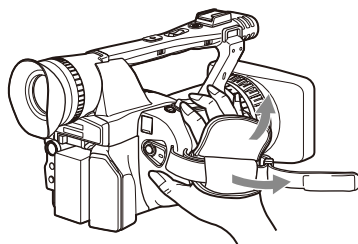

Attaching the shoulder strap

Attach the shoulder strap and use it as a precaution against dropping the camera.

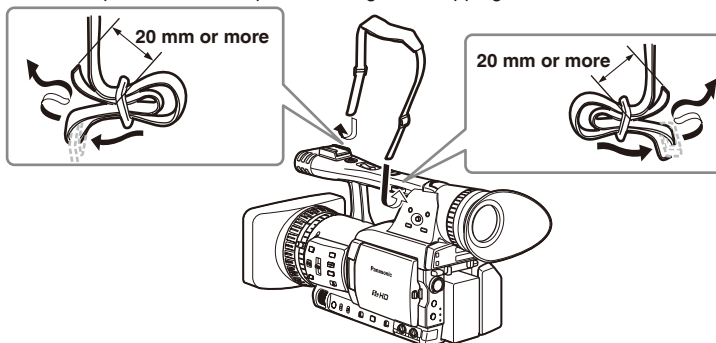

Detaching and attaching the lens hood

Detaching the lens hood

- Turn the lens hood counterclockwise to detach it.

Attaching the lens hood

- Turn the lens hood clockwise until it clicks to secure it in position.
- Be sure to attach the lens hood cap to protect the lens when not in use.

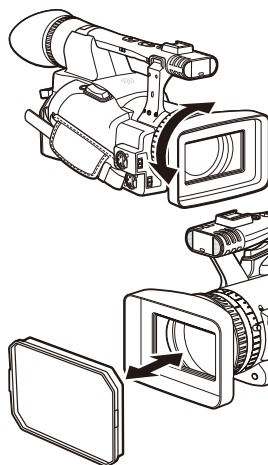

The remote control

Insert the battery

- 1 Push the catch in the direction shown by arrow to ① remove the holder.

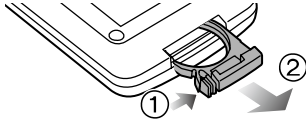

- 2 Insert the battery with the "+" marked side facing up.

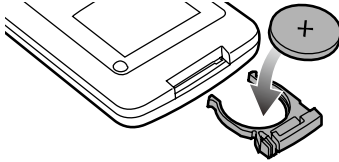

- 3 Return the holder to its original position.

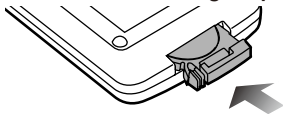

- When the battery (CR2025) has run out, replace it with a new one. (The battery lasts about one year, depending on the frequency of use.)
If the remote control unit fails to work even when it is operated near the camera-recorder's remote control sensor, the battery has run out.
- **Keep the battery out of the reach of children.**

Remote control setup

When using two camera-recorders simultaneously, set this camera-recorder and the remote control to either "operation mode 1" or "operation mode 2" so the remote control does not operate the wrong camera-recorder by mistake.

Setting

• Wireless remote control

Press the MCR operation buttons STOP (■) and STILL ADV (▶▶) at the same time to set the remote control unit for use in "operation mode 1". Alternatively, press the STOP (■) and STILL ADV (◀◀) buttons at the same time to set the remote control unit for use in "operation mode 2". When the battery in the remote control unit is replaced, the remote control unit is set for use in "operation mode 1".

• Camera

In the setup menus, OTHER FUNCTIONS screen, REMOTE, set to 1 or 2. (Page 111)

If different settings are used for the camera-recorder and remote control unit, "REMOTE" lights in red on the viewfinder and LCD monitor.

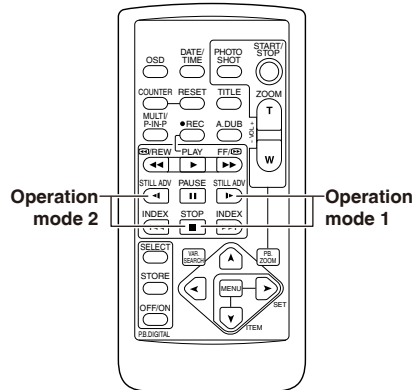

Turn on/off the camera

While pressing the lock release, turn the POWER switch.

Turn on the camera:

The mode lamp (CAM) lights red (CAM mode) and the camera is now in the shooting standby mode.

Turn off the camera:

The mode lamp (CAM) goes out.

- Power saving mode

When the camera is left idle in pause mode for about 5 minutes, it will behave as follows depending on what POWER SAVE settings have been made in the setting menu OTHER FUNCTIONS screen (Page 113).

ON: The camera-recorder turns off automatically.

OFF: The camera-recorder does not turn off automatically.

See the setup menus, OTHER FUNCTIONS screen, POWER SAVE (Page 113) for details.

- When the operation mode buttons flash in sequence starting with the top one and the power then goes off, it means that there is no charge left in the battery. Recharge the battery.

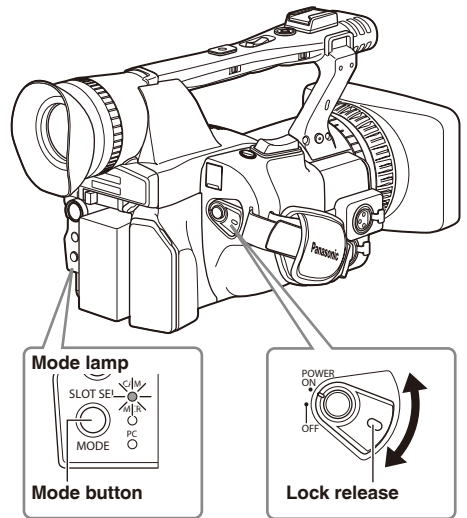

Preparation

Tally lamp

The tally lamp can be made to light up during shooting by selecting "ON" as the REC LAMP setting in the OTHER FUNCTIONS screen. (Page 112)

When the camera-recorder is in any of the following states, the tally lamp blinks.

- When an operation initiated by the remote control unit has been received (8 blinks/sec.)
- When the remaining battery capacity runs out (4 blinks/sec.)
- When the available recording space on the P2 card or the battery power is low (1 blink/sec.)
- When removing the P2 card during access (4 blinks/sec.)
- When there is no recording space left on the P2 card (4 blinks/sec.)

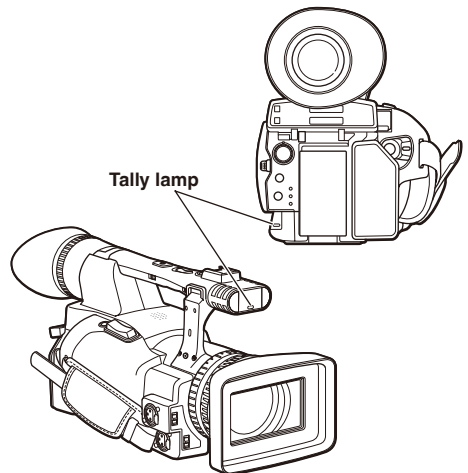

Viewfinder

This camera has two viewfinders; one is a miniature LCD in the viewfinder and the other is a retractable 3.5-inch LCD.

Use the viewfinder that best suits the application and shooting conditions.

- The brightness and hue may differ between the images appearing on the viewfinder and LCD monitor and those displayed on a TV monitor. To see how the final images will appear, check them on a TV monitor.
- Images are always displayed on the viewfinder.

Using the viewfinder

- 1 Set the POWER switch to ON and check that images appear in the viewfinder.**

- Keep the LCD monitor closed.



- 2 Adjust the viewfinder's angle so that the screen is positioned where it is easiest to see.**

- You can move the view finder out to about 90 degrees perpendicular to the camera.

- 3 Adjust the diopter adjustment lever so that you can see the characters on the viewfinder screen clearly.**

Viewfinder diopter dial

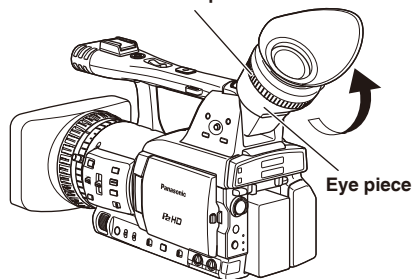

Do not point the eye piece at the sun or other strong light source.

- Light concentrated by the lens could damage internal components and poses a fire hazard.

Fitting the eye cup

Attach the eye cup by aligning the projections on the eye cup holder and eye cup and fitting them together.

- Turning the eye cup after attaching it may cause the eye cup holder to come off. If the eyecup holder does come off, see "Cleaning the Viewfinder" (Page 121) for details on how to refit it.

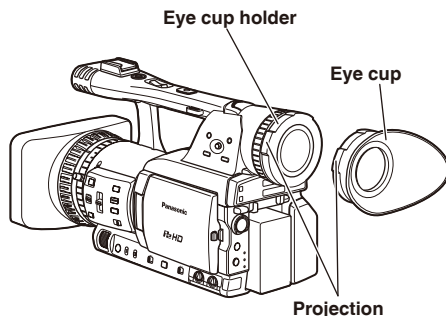

Using the LCD

- 1 Set the **POWER** switch to **ON**.
- 2 Hold down the **OPEN** button to open the LCD monitor.
 - It can open out to 120 degrees. Do not try to open it further as this will damage the camera.

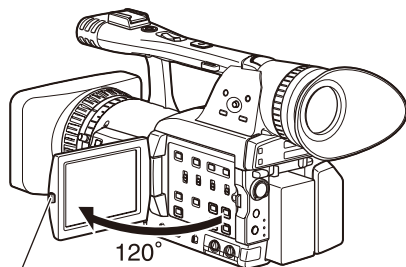

OPEN button

- 3 Position the LCD monitor where it is easiest to see.
 - The monitor can be rotated 180 degrees toward the lens and 90 degrees toward you.
 - **Do not apply unnecessary force to the open LCD. This can damage the camera.**

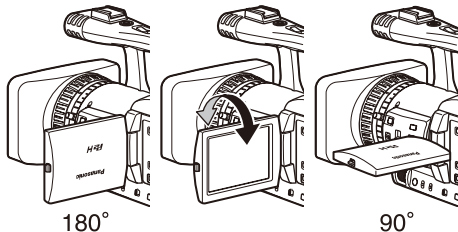

180°

90°

- Ensure the LCD is fully closed.

Emphasizing outlines

Emphasizing the outlines of the images you see in the viewfinder or on the LCD makes it easier to focus.

Emphasizing the outlines does not effect the images you shoot.

- 1 In **CAM** mode, press **EVF DTL**.
“EVF DTL ON” appears on the screen for about 2 seconds.

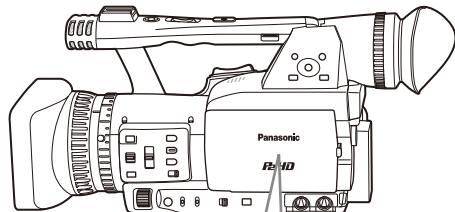

Preparation

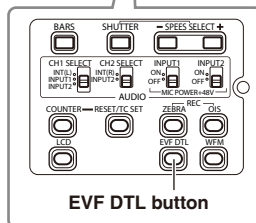

Press **EVF DTL** again to return to the original display. “EVF DTL OFF” appears on the screen for about 2 seconds.

Viewfinder (continued)

Adjusting the screen display

1 Set the POWER switch to ON. (Page 19)

2 Press the MENU button.

- For menu operation (Page 95)
- You can also use the menu buttons on the remote control. (Page 14)

3 Viewfinder adjustments

Select YES under EVF SET on the setting menu DISPLAY SETUP screen.

LCD monitor adjustments

Set YES under LCD SET on the setting menu DISPLAY SETUP screen.

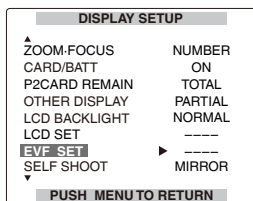

4 Push the Operation lever in the ▲ or ▼ direction to select the item.

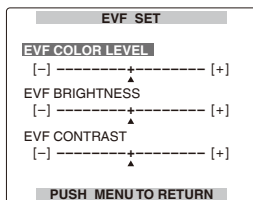

5 Push the Operation lever in the ◀ or ▶ direction to make adjustment.

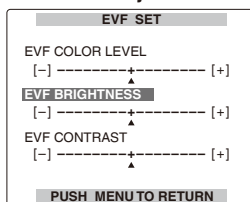

6 Press MENU three times to exit the menus.

- You can return the settings for EVF SET and LCD SET to the factory settings by selecting the item and pressing COUNTER RESET (if it is possible to change the item at that time).
- The viewfinder display can be in color or black and white. (See the setup menus, DISPLAY SETUP screen, EVF COLOR.) The resolution is the same for both of them.

Adjusting the backlight

The steps below show how to set the brightness of the LCD monitor to one of three possible levels.

1 Select LCD BL under LCD on the setting menu SW MODE screen.

This assigns LCD BL to the LCD button.

2 Press the LCD button.

Each press of the button switches backlight brightness in the following order: NORMAL (standard) → LOW (dark) → HIGH (bright) → NORMAL.

- These settings persist even when the camera-recorder is turned off.



Flipping images vertically and horizontally

Use this function to flip an image vertically or horizontally to check the aspect ratio or composition on the LCD monitor.

This feature affects only the image in the viewfinder or on the LCD monitor, not the recorded image.

1 Select LCD REV under LCD on the setting menu SW MODE screen.

This assigns LCD REV to the LCD button.

2 Press the LCD button.

- This button toggles between the normal and flipped image at each press.
- No screens are displayed when the image is flipped.
- The unit returns to normal image mode the next time it is powered up.



Switching between overscan and underscan

Use this function to underscan or overscan the image shown in the viewfinder or on the LCD monitor.

1 Select OVERSCAN under LCD on the setting menu SW MODE screen.

This assigns OVER SCAN to the LCD button.

2 Press the LCD button.

- This button toggles between overscan and underscan at each press.
- The unit returns to underscan mode the next time it is powered up.
- In overscan mode, a frame appears on the screen.



Setting the calendar

The CLOCK SET value is recorded in the contents (clip), and affects the sequence of playback of the thumbnails. Before carrying out recording, be sure to check and set CLOCK SET and TIME ZONE. This shows you how to adjust the calendar to 5:20 PM on December 25, 2008.

1 Set the POWER switch to ON. (Page 19)

2 Press the MENU button.

3 Push the Operation lever in the ▲ or ▼ direction to set the time difference from Greenwich Mean Time under TIME ZONE on the setting menu OTHER FUNCTIONS screen. (Page 113)

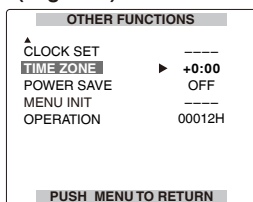

(Example of MENU in the CAM mode)

- For menu operation (Page 95)
- You can also use the menu buttons on the remote control. (Page 14)

4 In the setup menus, OTHER FUNCTIONS screen, CLOCK SET, select YES.

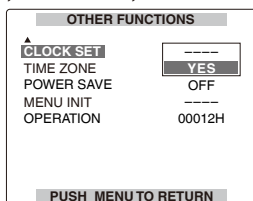

5 Push the Operation lever in the ◀ or ▶ direction to set YEAR to 2008.

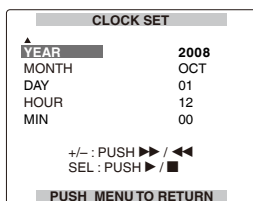

Choose a year between 2000 and 2030.

6 Push the Operation lever in the ▼ direction to move to the MONTH setting.

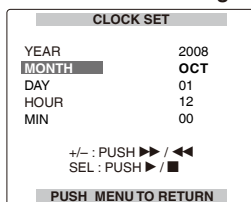

7 Push the Operation lever in the ◀ or ▶ direction to set MONTH to DEC.

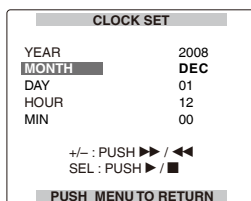

8 Set DAY, HOUR, and MIN using the method shown in steps 4 and 5.

- This is a 24-hour clock.

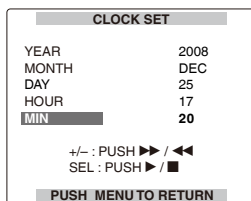

9 Press MENU three times to exit the menus.

- The clock can vary in accuracy so check that the time is correct before shooting.
- When using the camera overseas, do not set the CLOCK SET option to the local time, but instead enter the time difference from Greenwich mean time according to TIME ZONE.

Basic shooting operations

Preparing to shoot

- 1 Set the POWER switch to ON. (Page 19)
- 2 Lift up the viewfinder, press the side of the card slot cover (①), and slide the cover (②) to open it.
- 3 Insert the P2 card securely in the card slot.
- 4 Push the P2 card eject button to the direction of the arrow, and close the card slot cover.
 - There are two card slots.
 - Be absolutely sure to close the card slot covers to keep the dust out.
 - Do not remove the P2 card while the P2 card access lamps are blinking orange. (Page 26)

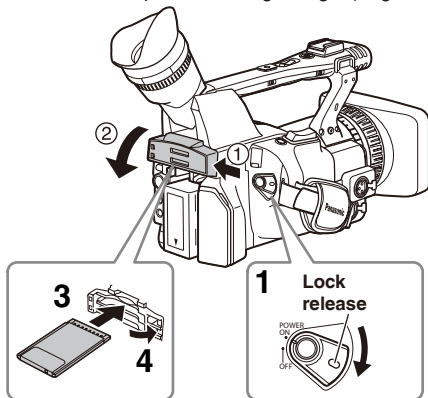

- 3 Press the START/STOP button (Red) on the POWER switch to start shooting.
 - Press again to return to the camera to the shooting standby mode.
 - Use the handle START/STOP button to make it easier to shoot from low angles.

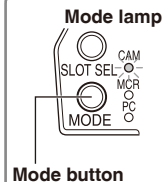
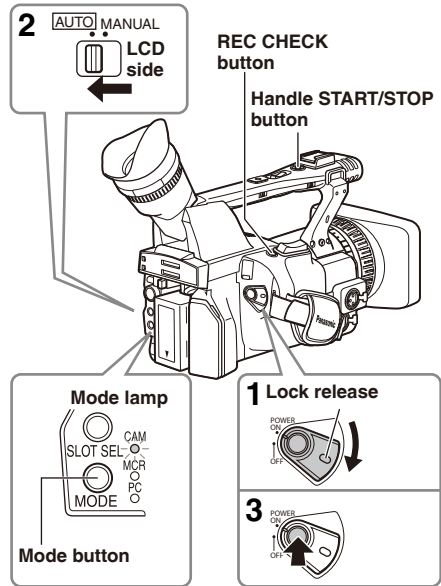

1 Lock release



3



Under the following circumstances, even if you press the STOP button it may take some time until the writing to the P2 card finishes. For this reason, the operation will not be acknowledged if you press the START button too soon.

- Stopped after only a short recording time
- Stopped immediately after the recording has moved to a second P2 card

Shooting in auto mode

- 1 Turn the POWER switch to ON. (Page 19)
 - Check that the mode lamp (CAM) is lighted red.
- 2 Switch the AUTO/MANUAL switch to AUTO to select auto mode.
 - “A” appears on the viewfinder and LCD screens.
 - The focus, gain, iris and white balance are adjusted automatically.

Basic shooting operations (continued)

Checking photos taken (REC CHECK)

In the shooting pause mode, press the REC CHECK button.

This plays back about 2 seconds of the video and audio of the most recently recorded clip before returning to pause mode.

- Note that this REC CHECK portion will also be recorded to any equipment you have set up to make backup recordings.
- The REC CHECK function does not work in PC and MCR mode.

The HD recording(1080i/50i (720P/60P)) settings are already made in the default mode.
(To view the current settings, see Page 42.)

P2 card access lamps

CAM mode (MCR)

Lights green:

Data can be saved onto the cards or loaded from them.

Blinks green (slow):

No available space on card, card is write-protected

Lights orange:

Slot that is the object of recording

Blinks orange:

Data is now being accessed.

Blinks orange (fast):

A card is now being recognized.

Both lamps blink orange:

Ejection of card during access

Off:

Cards have not been inserted or formatted.
Insertion of incompatible card.

PC mode (USB DEVICE)

Blinks orange: Data is now being accessed.

Off: A status other than access underway.

PC mode (1394 DEVICE)

Blinks orange: Connected

Off: Not connected

PC mode (1394 HOST)

Lights green:

Access standby.

Blinks orange:

Data is now being accessed.

Off:

Cards have not been inserted or formatted.
Insertion of incompatible card.

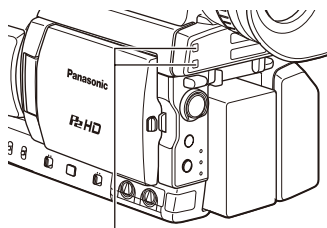

P2 card access lamp

Protecting against a possible erasure

Switch the write-protect switch of the P2 card to [PROTECT].

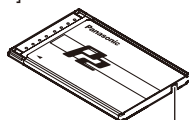

Write-protect switch



Formatting P2 cards

- 1 Set the POWER switch to ON. (Page 19)
- 2 Press the mode button and set it to MCR mode (the MCR lamp lights).
 - Thumbnails are displayed.

3 Press the MENU button.

- For menu operation (Page 95)

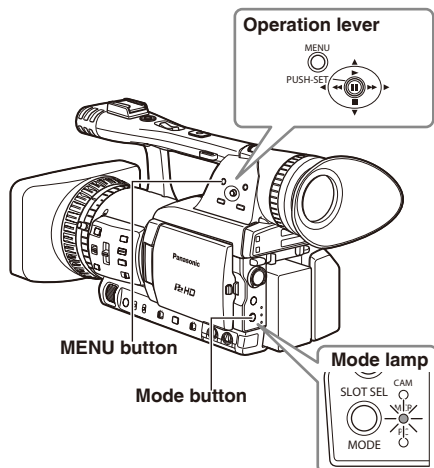

4 On the menu, select OPERATION and then FORMAT. (Page 69)

- A screen such as the one shown below appears. Select the number of the slot into which you inserted the P2 card to be formatted. Select EXIT to cancel the formatting.
- When you press the MENU button, the menu display disappears.

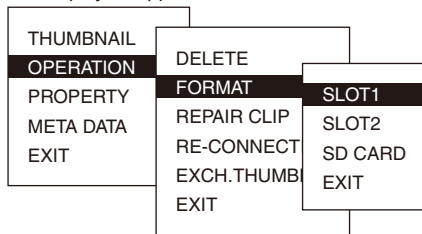

5 Select YES on the confirmation screen.

- The selected P2 card is formatted.

Recording times

Card model	Capacity	DVCPRO/DV 2-channel audio	DVCPRO50 4-channel audio	DVCPRO HD*1	DVCPRO HD 720P/24PN	DVCPRO HD 720P/25PN (720P/30PN)
AJ-P2C004HG	4 GB	approx. 16 min.	approx. 8 min.	approx. 4 min.	approx. 10 min.	approx. 8 min.
AJ-P2C008HG	8 GB	approx. 32 min.	approx. 16 min.	approx. 8 min.	approx. 20 min.	approx. 16 min.
AJ-P2C016RG	16 GB	approx. 64 min.	approx. 32 min.	approx. 16 min.	approx. 40 min.	approx. 32 min.
AJ-P2C032RG	32 GB	approx. 128 min.	approx. 64 min.	approx. 32 min.	approx. 80 min.	approx. 64 min.

- The AJ-P2C002SG (2 GB) card cannot be used.**
- The displayed available space includes the management area, and so the space available for recording is smaller than this.
- Concerning the division of clips recorded on P2 cards**
When using a P2 card of at least 8 GB in this camera, if the continuous recording time for a single session exceeds the time shown in the following table, recording will be automatically resumed as a different clip. When performing a thumbnail operation (display, delete, restore, copy, etc.) on clips using P2 cards, you can operate them as a single clip. When you are using non-linear editing software and a PC, for example, the clips are displayed individually.

Recording Format	Recording times
DVCPRO HD*1	approx. 5 min.
DVCPRO50	approx. 10 min.
DVCPRO/DV	approx. 20 min.

*1 The 720P/25PN (720P/30PN and 720P/24PN) formats are not included in the DVCPRO HD recording format.

- When using any other types of cards, the driver installed in the camera-recorder may need to be updated. (Page 120)
- For the latest information not available in the Operating Instructions, visit the P2 Support Desk at the following Web sites.
<https://eww.pavc.panasonic.co.jp/pro-av/>

Basic shooting operations (continued)

Remove the P2 card

- 1** Lift up the viewfinder, press the side of the card slot cover (①), and slide the cover (②) to open it.
- 2** Check that the P2 card access lamp is not blinking orange.
- 3** Raise the P2 card eject button and press it.
- 4** Remove the P2 card.

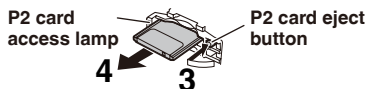
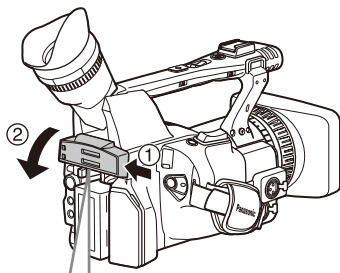

- During playback, a P2 card inserted into the empty slot will not be recognized and the P2 card access lamp will not light. When playback is completed, the P2 card recognition will begin.
- You can use ACCESS LED on the OTHER FUNCTIONS screen to set the P2 card access lamps so that they will always be off. In this case, either turn off the power or wait until enough time has passed after inserting the cards or stopping operation before ejecting the cards.
- If a P2 card is ejected while thumbnails are displayed, the thumbnail screen is released.

Cautions in using P2 cards

Before using a P2 card, be sure to format it with a P2 device.

- Do not eject the P2 card or turn the power off under the following circumstances, since doing so may cause a malfunction in the card:
 - 1) While the orange P2 card access lamp is blinking after the card is inserted (and until it stops blinking).
 - 2) During recording, during the recording finish process, or while the access lamp is blinking.
- If a P2 card is ejected during formatting or while its data is being accessed, "TURN POWER OFF" appears in the viewfinder, and a warning is indicated by the tally lamp. If this happens, turn the power off and back on again.
 - When a card is ejected during formatting:
Format the card again.
 - When a card is ejected while its data is being accessed:
The clips may be thrown out of order.
(Page 58) Check the clips and repair them.
(For details on repairing clips, see Page 69.)
- Immediately after pre-recording, a P2 card inserted into an empty slot will not be immediately recognized.

Using SD/SDHC memory cards

You can use SD and SDHC memory cards (the term "SD memory card" is used for both hereafter) to save and load SCENE files and USER files, and to upload clip meta data. (Page 56)

Installing and removing the SD memory card

Installation

- 1 Lift up the viewfinder, press the side of the card slot cover (①), and slide the cover (②) to open it.
- 2 Insert the card while making sure it is oriented in the proper direction.

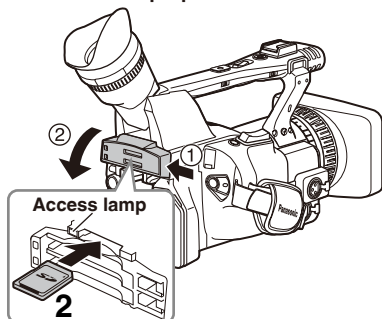

- 3 Close the card slot cover.

Removal

- 1 Open the card slot cover, and check that the access lamp is not lit.
- 2 Press the card further into the unit, grasp the card, and then remove.
- 3 Close the card slot cover.

Formatting SD memory card

- 1 Set the POWER switch to ON. (Page 19)
- 2 Press the mode button and set it to MCR mode (the MCR lamp lights).
- 3 Press the MENU button.
- 4 On the menu, select OPERATION, FORMAT and then SD CARD. (Page 69)
 - Select EXIT to cancel the formatting.

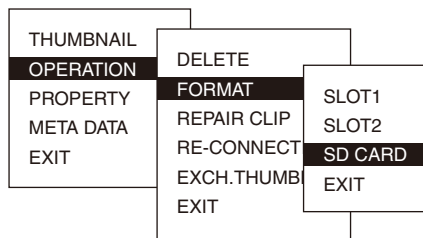

- 5 Select YES on the confirmation screen.
 - The selected SD memory card is formatted.

- You can also format from the SD CARD FORMAT option on the CARD FUNCTIONS screen. (Page 111)
- With SDHC cards, 32 KB of capacity will have been used.

Cautions in using SD memory cards

- SD memory cards used with the AG-HPX171E should conform to SD or SDHC standards. Be sure to format cards using the AG-HPX171E. SD memory cards with the following capacity can be used for the AG-HPX171E.

SD (from 8 MB to 2 GB):

8 MB	16 MB	32 MB	64 MB	128 MB
256 MB	512 MB	1 GB	2 GB	

SDHC (4 GB to 16 GB):

4 GB	8 GB	16 GB
------	------	-------

For the latest information not available in the Operating Instructions, visit the P2 Support Desk at the following Web sites.

<https://www.pavc.panasonic.co.jp/pro-av/>

- SD memory cards must not be used or stored in an environment where they may be Exposed to high temperatures/humidities; Exposed to water droplets; or Electrically charged.
- Be sure always close the cover when using an SD memory card.
- See also "Checkpoints for using memory cards" on Page 124.

Using the zoom function

This camera has a 13 x optical zoom function.
Zoom with the zoom button or the zoom ring.

Zoom button

Set the ZOOM switch to SERVO so that you can use the motor-driven zoom.

- T : Zoom in
- W : Zoom out

Gently press the zoom button on the grip to zoom slowly, firmly press to zoom faster.

You can change the zoom speed on the handle zoom button by selecting one of three speeds with the HANDLE ZOOM switch.

Set the HANDLE ZOOM switch speeds by going to the setup menus, SW MODE screen HANDLE ZOOM (Page 102).

HANDLE ZOOM switch

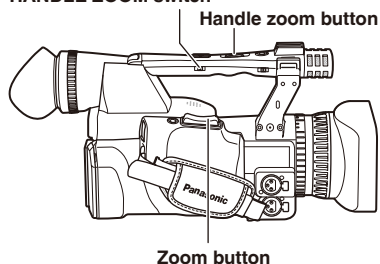

Zoom ring

Set the ZOOM switch to MANUAL so that you can use the zoom ring.

- You cannot use the zoom ring if the ZOOM switch is set to SERVO. Trying to use it could damage the camera.

Zoom ring

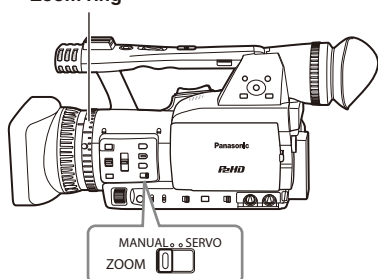

On the remote control

Press ZOOM/VOL to zoom with the motor drive.

- Zoom speed is fixed at medium.

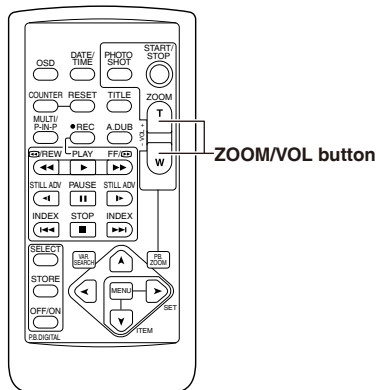

Digital zoom function

Assign the D.ZOOM function to any of the USER 1 – 3 buttons to enable use of the digital zoom. (Page 43)

Each press of the USER button to which D.ZOOM is assigned switches the zoom ratio in the following order: OFF (x1) → x2 → x5 → x10 → OFF (x1).

- The viewfinder and the LCD monitor indicate the zoom ratio when a setting other than OFF (x1) is selected.
- Digital zoom is available only in the 1080i/50i (60i) format.
- Digital zoom is not available when OFF is selected under DRS (Page 100) on the setting menu SCENE FILE screen.
- While using the zoom function, the slow shutter is disabled. While using the slow shutter, you cannot use the digital zoom function.
- Digital zoom cannot be changed during recording.

Variable frame rates (VFR)

By taking full advantage of the special characteristics of P2 cards, this unit provides frame skipping (undercranking) recording and highspeed (overcranking) recording, which are actually movie techniques, without the use of a frame rate converter. (Either the 25PN (30PN or 24PN) mode must be set for this.) Since the camera-recorder records only the effective frames (native recording), recording is possible for 2 times as long compared with recording in the 25P or 50P mode (standard recording), and for between 2 times and 2.5 times as long compared with recording in the 24P, 30P or 60P mode (standard recording).

As with Panasonic's Varicam model (AJ-HDC27 series), this unit also provides a recording format that allows frame rate conversion using nonlinear editing. (Either the 25PN (30PN or 24PN) mode must be set for this.)

25PN mode:

The camera-recorder shoots in the 25 fps native mode. The video signals delivering images at a rate of 25 fps are recorded in 25 frames. The signals are recorded only in the effective frames so recording is possible for 2 times as long.

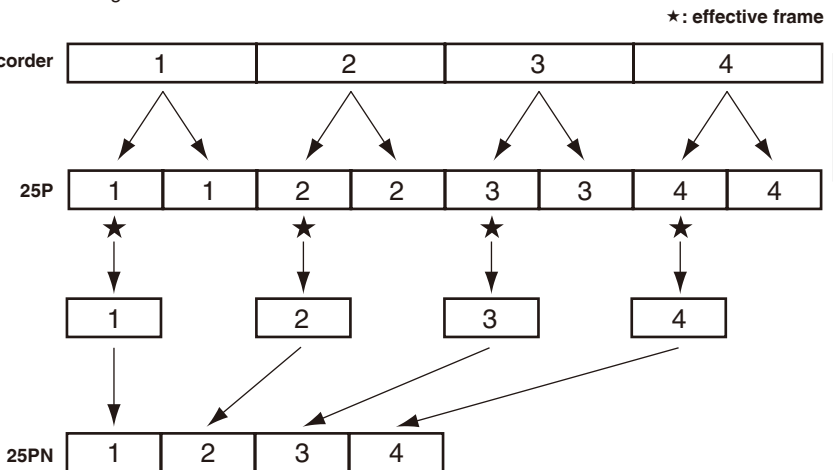

- Before VFR shooting, you must set the recording frame rate and recording format ahead of time.
- You cannot change the frame rates while recording.
- VFR shooting is possible only in progressive-shooting mode with 720 vertical lines.

You can select any of 20 recording frame rates ranging from 12 frames per second (fps) to 50 (60) fps. The list of formats that allow recording by the camera-recorder (Page 125).

Variable frame rates (VFR) (continued)

24PN mode:

The camera-recorder shoots in the 24 fps native mode. The video signals delivering images at a rate of 24 fps are recorded in 24 frames. The signals are recorded only in the effective frames so recording is possible for 2.5 times as long.

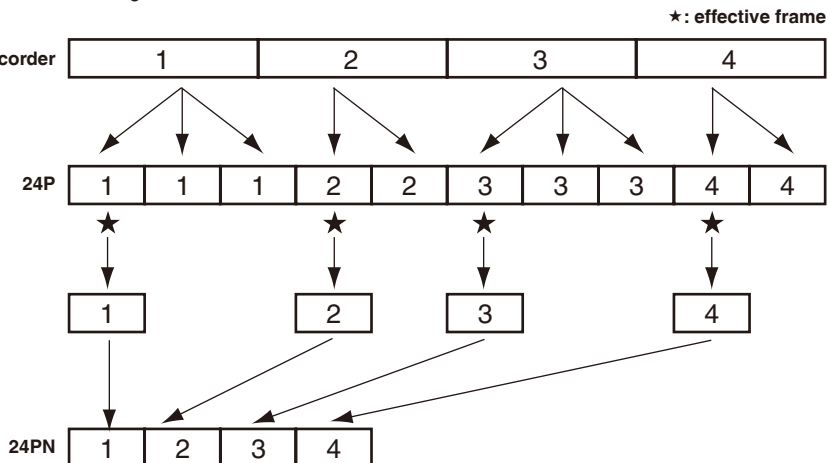

- Before VFR shooting, you must set the recording frame rate and recording format ahead of time.
- You cannot change the frame rates while recording.
- VFR shooting is possible only in progressive-shooting mode with 720 vertical lines.

You can select any of 20 recording frame rates ranging from 12 frames per second (fps) to 50 (60) fps. The list of formats that allow recording by the camera-recorder (Page 125)

There may be slight discrepancies between the recording frame rate displayed and the frame rate at which the images are actually recorded. Refer to the table below.

- When SYSTEM FREQ is set to 50 Hz

Indicated recording frame rate	50	48	45	42	37	34	32	30	28	27	26	25	24	23	22	21	20	18	15	12
Actual recording frame rate	50.00	48.08	45.00	41.67	36.76	34.09	32.14	29.76	28.13	27.17	26.04	25.00	24.04	23.15	22.06	20.83	19.74	17.86	15.00	12.50

- When SYSTEM FREQ is set to 59.94 Hz

Indicated recording frame rate	60	54	48	44	40	36	34	32	30	28	27	26	25	24	22	21	20	18	15	12
Actual recording frame rate	59.94	53.95	48.17	44.07	39.43	35.68	33.72	32.11	29.97	28.10	26.97	26.44	24.98	23.98	22.48	21.41	19.55	17.98	14.99	12.26

Native recording

- 1 Using the **REC FORMAT** function (Page 105) on the **RECORDING SETUP** screen, select **720P/25PN (720P/30PN)** or **720P/24PN** as the recording format.
- 2 Select the appropriate scene file using the **SCENE FILE** dial.
If necessary, before doing this, perform the camera settings from the setting menu, and register the scene file. (Page 54)
- 3 Using the **OPERATION TYPE** function (Page 99) on the **SCENE FILE** screen, select **FILM CAM**, and set the desired recording frame rate using the **FRAME RATE** function (Page 99).
- 4 Press the **START/STOP** button to start or stop native recording in **VFR mode**.
 - No signals are output from the 1394 terminal during recording or recording standby in the native mode.
 - Sound is not recorded. However, sound will be recorded when the same frame rate is used for both recording and playback.
 - When a recorded clip lasting a long time is to be played back and imported using a nonlinear editing system that supports Varicams, the **UB MODE** option on the **RECORDING SETUP** screen must be set to **FRM.RATE**.
 - If the effective frame information is to be carried over when recording onto this camerecorder from a nonlinear editing system that supports Varicams, the **1394 UB REGEN** option on the **RECORDING SETUP** screen must be set to **ON**.
 - After editing, materials are output from the nonlinear editing system in **1080i/25P (1080i/24P)** or **720P/50P (25P over 50P (720P/60P (24P over 60P)))** format.

Standard recording

- 1 Using the **REC FORMAT** function (Page 105) on the **RECORDING SETUP** screen, select **720P/50P (720P/60P)**, **720P/25P (720P/30P)** or **720P/24P** as the recording format.
- 2 Select the appropriate scene file using the **SCENE FILE** dial.
If necessary, before doing this, perform the camera settings from the setting menu, and register the scene file. (Page 54)
- 3 Using the **OPERATION TYPE** function (Page 99) on the **SCENE FILE** screen, select **FILM CAM**, and set the desired recording frame rate using the **FRAME RATE** function (Page 99).
When **720P/25P (720P/30P)** or **720P/24P** has been selected as the recording format, the following displays appear depending on the setting which has been selected for the **FRAME RATE** item on the **SCENE FILE** screen.
 - 1) **PULL DOWN** information displayed in **PROPERTY-CLIP PROPERTY-VIDEO**
With the default setting: **2:2** or **2:3**
With any other settings: **other**
 - 2) Format information in the bottom left of the screen when thumbnails are displayed
With the default setting:

720P/25P (720P/30P) or 720P/24P
720P/50P (720P/60P)

 (The "default" setting is **25FRAME** if the frame rate of the recording format is **25P** or **30FRAME** if it is **30P (24FRAME** if it is **24P))**.
- 4 Press the **START/STOP** button to start or stop standard recording in **VFR mode**.
 - Sound is recorded.
 - In the case of a nonlinear editing system that supports Varicams equipped with an effective frame extraction function, you can upload even undercrank or overcrank shooting materials as is. (The **UB MODE** option on the **RECORDING SETUP** screen must be set to **FRM.RATE**.)
 - After editing, materials are output from the nonlinear editing system in **1080i/25P (24P)** or **720P/50P (25P over 50P (720P/60P (24P over 60P)))** format.
 - The **25P (30P)** format is used for **2:2** pull-down recording; the **24P** format is used for **2:3** pull-down recording.

Variable frame rates (VFR) (continued)

Using variable frame rates (VFR)

Standard speed shooting for movie production

When making movies to show on a screen, a frame rate of 24 fps (frames per second), which is the same as for films, is the norm (1x speed). If you use the settings below, the same kind of playback as with screenings can be obtained. By using the 720P progressive mode and cine-like gamma, high-quality film-like images can be achieved.

Recording format (REC FORMAT)	Recording frame rate (FRAME RATE)
720P/24P (2:3 pull-down)	24 fps*
720P/24PN (native recording)	

Standard speed shooting for making commercials and dramas

When producing commercials and dramas to be shown on a TV screen, as in the case of HDTV/SDTV and other broadcasts, a frame rate of 25 (30) fps (frames per second) is the norm (1x speed).

If you use the settings below, the same kind of playback as when the programs are broadcast can be obtained. Commercials and music clips will be recorded with a high film-like picture quality while the number of frames is also ideally suited to TV broadcasts.

Recording format (REC FORMAT)	Recording frame rate (FRAME RATE)	
50 Hz	720P/25P (2:2 pull-down)	25 fps*
	720P/25PN (native recording)	
59.94 Hz	720P/30P (2:2 pull-down)	30 fps*
	720P/30PN (native recording)	

Undercrank shooting

This way of shooting provides quick motion effects used to present such scenes as the movement of clouds, someone standing among crowd of people, and moves made by martial artists. If, for instance, you have shot scenes using the 25P (24P) recording format for specifying the playback frames, you can double the speed of the quick motion effects by setting the VFR recording frame rate to 12 fps.

Recording format (REC FORMAT)	Recording frame rate (FRAME RATE)
720P/25P, 720P/25PN	Set to 24 fps or lower.*
720P/24P, 720P/24PN	Set to 22 fps or lower.*
720P/30P, 720P/30PN	Set to 28 fps or lower.*

- In the case of the 720P/25P (720P/30P) and 720P/24P formats, the quick motion effect can be obtained by using a nonlinear editing system to process what has been recorded.

Overcrank shooting

This way of shooting provides slow motion effects used to show car chases as well as action scenes, climax scenes and other dramatic presentations. If, for instance, you have shot scenes using the 25P (30P) recording format for specifying the playback frames, you can obtain slow motion effects with the speed halved by setting the recording frame rate to 50 (60) fps. Images in the 720P progressive format will create smoothly flowing slow motion sequences with a high picture quality.

Recording format (REC FORMAT)	Recording frame rate (FRAME RATE)
720P/25P, 720P/25PN	Set to 26 fps or higher.*
720P/24P, 720P/24PN	Set to 25 fps or higher.*
720P/30P, 720P/30PN	Set to 32 fps or higher.*

- In the case of the 720P/25P (720P/30P) and 720P/24P formats, the slow motion effect can be obtained by using a nonlinear editing system to process what has been recorded.

* You can select any of 20 recording frame rates ranging from 12 frames per second (fps) to 50 (60) fps. (Page 99)

Shooting in 1080i/576i (480i) progressive mode

Shooting in 1080i/576i progressive mode

Selecting 1080i/25P or 576i/25P in the REC FORMAT option (Page 105) of the setting menu RECORDING SETUP screen enables shooting in progressive mode.

25P mode:

Shoot 25 frames a second in the progressive mode.

For output and recording, the 25-frame-persecond signal is converted to 50-field-per-second interlace.

This mode gives you high quality images.



Note the following when shooting in progressive mode.

- You cannot have a gain of 18 dB.
- Set the shutter speed to 1/50 (OFF) for best results.

Shooting in 1080i/480i progressive mode

Selecting 1080i/30P, 1080i/24P, 1080i/24PA, 480i/30P, 480i/24P or 480i/24PA in the REC FORMAT option (Page 105) of the setting menu RECORDING SETUP screen enables shooting in progressive mode.

30P mode:

Shoot 30 frames a second in the progressive mode.

For output and recording, the 30-frame-persecond signal is converted to 60-field-per-second interlace.

This mode gives you high quality images.



24P mode:

Shoot 24 frames a second in the progressive mode.

For output and recording, the 24-frame-persecond signal is converted to 60-field-per-second interlace using the widely used "2:3" ratio. This gives you images similar to a movie shot with film.



24P advanced mode:

Shoot 24 frames a second in the progressive mode.

For output and recording, the 24-frame-persecond signal is converted to 60-field-per-second interlace using "advanced" conversion.



With the "2:3" method, frames [BoCe], [CoDe], [FoGe], and [GoHe] shown in the illustration would be extended over different frames which can cause a drop in picture quality.

With the 24P advanced method, however, frames [BoCe] and [FoGe] are cut out, leading to a reduction in image quality loss.

If you also use a system compatible with the advanced method, editing will also yield better quality images than those shot in the normal 24P mode.

- If you are not going to do your editing on such a system, use the normal 24P method for shooting.

Note the following when shooting in progressive mode.

- You cannot have a gain of 18dB.
- Set the shutter speed to 1/50 (OFF) or 1/60 for best results.
- There may be a slight delay to the start of recording when you use the 24P or 24PA advanced modes because 5 frames are recorded at a time.

Shooting in manual mode

Set the unit to manual mode when manually adjusting the focus, iris, gain and white balance.

Switching to manual mode

Slide the AUTO/MANUAL switch to MANUAL to switch to the manual mode. ([A] on the viewfinder and LCD go out).

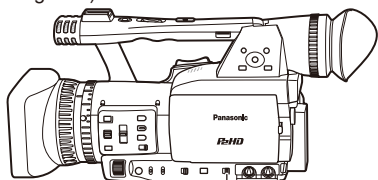

AUTO/MANUAL switch

Manual focusing

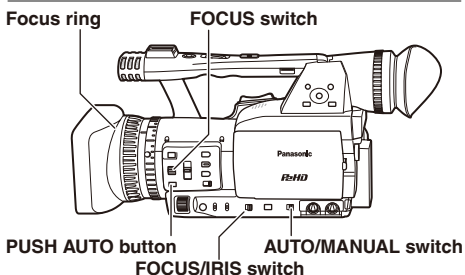

1 Use the AUTO/MANUAL switch to switch to manual mode.

2 Use the FOCUS switch to choose how to control focusing.

A (AUTO):

Auto focus mode

M (MANUAL):

Manual focus mode

Turn the focus ring by hand.

∞ :

The camera first focuses on infinity, then it switches to manual focus.

The FOCUS switch automatically moves back to M (MANUAL) after you move it to ∞ .

3 Use the FOCUS RING (FOCUS/IRIS) switch to change the function assigned to the focus ring.

FOCUS: Adjusts focus.

IRIS: Adjusts iris (aperture).

- When setting the FOCUS switch to M, also set the FOCUS RING (FOCUS/IRIS) switch to FOCUS.

Temporarily switching to auto focus

Even if you have switched FOCUS to M (MANUAL) the camera will focus automatically while you press down PUSH AUTO.

Switching to manual focus assist mode

To change from the manual focus mode to the manual focus assist mode, set MF ASSIST to ON on the setting menu SW MODE screen.

- You can make coarse adjustments to the focus in manual focus assist mode by turning the focus ring about half the amount you would turn it in manual focus mode.
- Fine adjustment is made automatically after you operated the focus ring.
- If the focus differs considerably from the manually set focus, the focus may not be set correctly.
- Automatic adjustment is not performed until you operate the focus ring for the next time.
- Auto focus may not work properly if there is flickering.
Select a shutter speed suited to the ambient light. (Page 50)
- If the auto focus mode is set with any format except 50i (60i) and 50P (60P), controlling the focus will take slightly longer than in the normal focus mode.
- If you have set ON for the AF item on the setting menu AUTO SW screen, auto focusing will occur regardless of the position of the FOCUS switch when the auto mode has been established. (Page 105)
- During macro shooting "AF", "MF" or "MA" will be displayed in a frame on the screen.

Using focus assist

Pressing the FOCUS ASSIST button magnifies the center portion of the image or brings up a frequency distribution graph at the top right of the image to assist during manual focusing. You can use the FOCUS ASSIST setting on the SW MODE screen to change the viewfinder and LCD monitor displays that appear when the FOCUS ASSIST button is pressed. (Page 104)

FOCUS ASSIST button

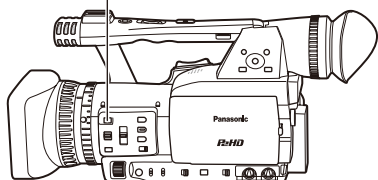

EXPANDED:

Doubles the size of the center of the image.

GRAPH:

Displays a frequency distribution graph at the top right in the viewfinder and LCD monitor.

Turn the focus ring on the lens to place the graph further to the right.

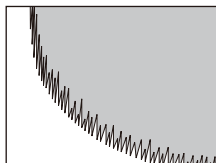

Out of focus

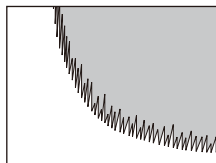

The white area moves to the right as the image comes into focus.

BOTH:

Magnifies the center portion of the image and displays the frequency distribution graph.

- The image on the LCD monitor may differ slightly from the image in the viewfinder when the FOCUS ASSIST button is used in EXPANDED mode.
- The EXPANDED mode is available during 1080i and 720P HD mode recording and standby, but does not work in external input mode.
- In the 576i (480i) SD format, only the GRAPH display is available. When set to the EXPANDED mode, the focus assist function does not work. Even when the BOTH mode is set, only the GRAPH display is available.
- The FOCUS ASSIST button does not work when the digital zoom function is used.

To return to the previous screen, press the FOCUS ASSIST button again.

Iris adjustments

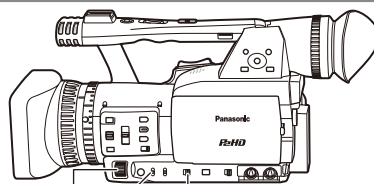

IRIS dial FOCUS RING (FOCUS/IRIS) switch
IRIS button

- 1 If the camera is in auto mode, use the AUTO/MANUAL switch to switch to manual mode. (Page 36)
- 2 Press the IRIS button to switch how to adjust the aperture of lens.
AUTO IRIS: Adjust the iris automatically.
MANUAL IRIS: Adjust the iris manually.
- 3 Turn the IRIS dial to adjust the aperture of lens when in the manual iris mode.
In the auto iris mode, the lens iris can be corrected using this dial.

Set the direction of the IRIS DIAL and aperture control in the setup menus, SW MODE screen, IRIS DIAL. (Page 102)

If you have set ON under A.IRIS on the setting menu AUTO SW screen, auto iris will be forcibly selected when auto mode has been established. (Page 104)

- Setting the FOCUS RING (FOCUS/IRIS) switch to IRIS allows you to set aperture using the focus ring on the lens. Note that since the focus ring now does not control focus adjustment, set the FOCUS switch to A (AUTO) focus control. (Page 36)

This unit's iris F number when it is open is F1.6 at full WIDE and F3.0 at full TELEPHOTO.

The iris display in the viewfinder or on the LCD when the iris is open is OPEN at full WIDE and F2.8 or OPEN at full TELEPHOTO.

Shooting in manual mode (continued)

Adjusting the gain

When the display is dark, increase the gain to brighten the display.

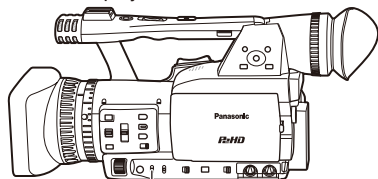

GAIN switch

- 1** If the camera is in auto mode, use the **AUTO/MANUAL** switch to switch to manual mode. (Page 36)
- 2** Switch the gain with the **GAIN** switch.
 - L:** Set here under normal conditions. (0 dB)
 - M:** Increase the gain of the image amplifier. (The default value is 6 dB.)
 - H:** Increase the gain of the image amplifier. (The default value is 12 dB.)

You can change the M and H gain values using the MID GAIN and HIGH GAIN items on the setting menu SW MODE screen. (Page 102)

In auto mode, auto gain is available regardless of the GAIN switch setting when a setting other than OFF is selected under AGC on the setting menu AUTO SW screen. (Page 105)

When the recording frame rate is less than 23 (22) fps and when a slow shutter speed (1/12 (1/15)) has been set, the gain is fixed at 0 dB regardless of the GAIN switch setting. (Pages 31 and 50)

Light intensity adjustments

Use the ND FILTER Switch to change the ND Filter used (filter to change light intensity).

- OFF:** ND filter is not used.
- 1/4:** Cuts light intensity by up to about 1/4.
- 1/16:** Cuts light intensity by up to about 1/16.
- 1/64:** Cuts light intensity by up to about 1/64.

ND FILTER switch

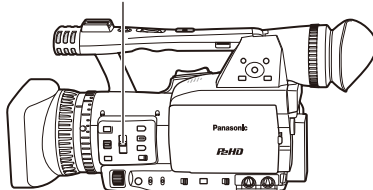

Adjusting the white balance

In order to reproduce the white accurately, adjust the ratio between the three RGB primary colors. If the white balance is not adjusted properly, not only will the white be reproduced poorly but the color tones of the entire screen will also be downgraded. When you are shooting in manual mode, readjust the white balance whenever lighting conditions change.

You can save adjustments and reselect them by setting the WHITE BAL switch to A or B.

You can also use the preset values.

Use the settings to suit the shooting conditions.

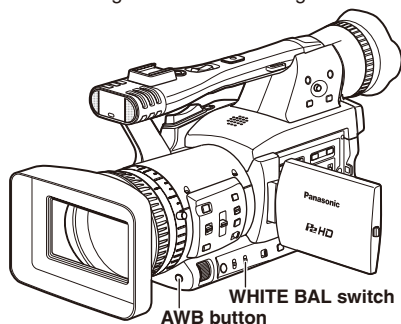

White balance adjustments

- 1 If the camera is in auto mode, use the AUTO/MANUAL switch to switch to manual mode. (Page 36)
- 2 Set the shutter speed. (Page 50)
- 3 Place a white pattern in a location with the same lighting conditions and light source as the subject, then zoom in and fill the whole screen with white.
Something white (a white cloth or wall) near the subject can be used instead.
 - Do not include bright spotlights in your shot.
- 4 Set the WHITE BAL switch to A or B (whichever one you want to save the adjustment in).

5 Press the AWB button.

- Adjustment takes a few seconds. (The following messages appear on the screen.)

Message during adjustment

AWB Ach ACTIVE

Message after adjustment

AWB Ach OK

An error message appears on the screen when white balance adjustment is not possible.

Message when adjustment cannot be done

AWB Ach NG

- White balance cannot be adjusted if the Auto Tracking White (ATW) function is working. If you have set ON under ATW (Auto Tracking White) on the setting menu AUTO SW screen, ATW will be selected when auto mode has been established regardless of the WHITE BAL switch position. (Page 105)

Make the necessary adjustments if one of the following error messages appears, then try adjusting the white balance again.

Error messages	Adjustments
LOW LIGHT	Increase light or increase the gain.
LEVEL OVER	Reduce light or decrease the gain.

- If the messages repeatedly appear even after trying a number of times, consult your dealer.

Shooting in manual mode (continued)

Using presets

Use this feature when you have no time to make white balance adjustments.

1 If the camera is in auto mode, use the **AUTO/MANUAL** switch to switch to manual mode (**A** on the viewfinder and LCD goes out).

2 Set the **WHITE BAL** switch to **PRST**.

The current white balance value appears.

- White balance values 3200 K and 5600 K are preset in the PRST position.

Guide to the preset values
P3.2K (3200 K): halogen light
P5.6K (5600 K): outdoors

3 Press the **AWB** button.

White balance switches between 3200 K and 5600 K.

Black balance adjustments

In order to reproduce the black accurately, adjust the zero level of all three RGB primary colors. If the black balance is not adjusted properly, not only will the black be reproduced poorly but the color tones of the entire screen will also be downgraded.

It is not normally necessary to adjust the black balance. Adjust it when:

- You use the camera for the first time.
- You use the camera after not using it for a long time.
- The ambient temperature changes greatly.
- You switch to the normal (OFF) shutter speed or to slow shutter.
- You switch between the progressive and normal (50i (60i)) modes.

Press the **AWB** button to automatically adjust the white balance.

Press and hold the **AWB** button to adjust the black balance.

- As the white balance is adjusted first when you press the **AWB** button, make the necessary preparations for this.

- You cannot adjust the black balance while you are shooting.

Message during adjustment

ABB ACTIVE

Message after adjustment

ABB END

- Hold down the **AWB** button to adjust the black balance (available also when the **ATW** function is used).

Auto Tracking White (ATW)

You can allocate the **ATW** feature to one of the positions on the **WHITE BAL** switch (A, B, or PRST). Allocate it by going to the setup menus, **SW MODE** screen, **ATW**. (Page 102)

The **ATW** feature is set to work in the auto mode at the time of shipping. (Page 105)

If you use the **ATW** feature whenever you are shooting, the camera automatically adjusts the white balance as you shoot.

- The **ATW** feature automatically determines the current shooting environment and adjusts the white balance accordingly. Depending on the environment, there may be some error in the adjustment.

Use the procedure described on the preceding page whenever you need more precise white balance.

Do not block the white balance sensor when using the **ATW** feature. **ATW** will not work if you do.

White balance sensor

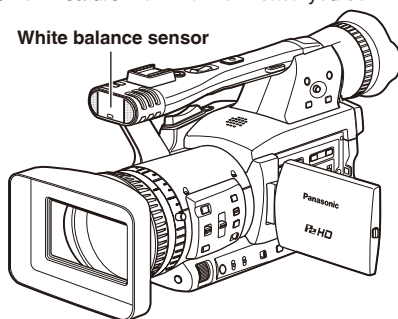

Shooting techniques for different targets

Low-angle shooting

Set the Recording enable/disable switch to ON and use the START/STOP button on the handle to make it easier to shoot from low angles.

- Set the Recording enable/disable switch to OFF to prevent inadvertent use of the START/STOP button on the handle when this function is not needed.

Recording enable/disable switch

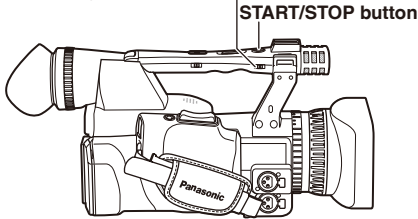

Self-portrait shooting

Images in the LCD when it is turned 180 degrees for self-portrait shooting may appear unusual.

You can make them appear better by reversing left and right. Go to the setup menus, DISPLAY SETUP screen, SELF SHOOT, and select MIRROR.

Shooting in mirror mode has no effect on what you actually shoot and record.

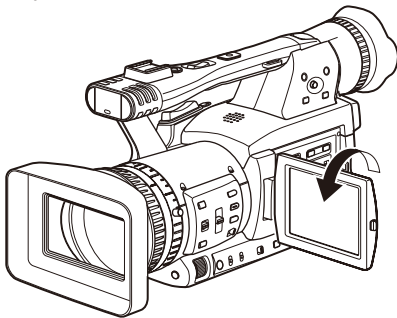

Zebra pattern

Press the ZEBRA button in CAM mode to show the zebra pattern or marker on the screen so you can check the brightness of the subject.

Parts that may be whited out through over exposure are shown as a zebra pattern.

- Very bright
- Reflecting parts

You can remove most overexposed parts by adjusting the iris and shutter speed in the manual mode to remove the areas with zebra patterns.

The display changes as follows each time you press the ZEBRA button.

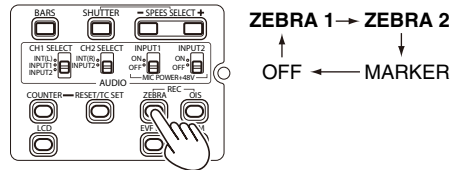

In the setup menus, DISPLAY SETUP screen, ZEBRA DETECT 1 and ZEBRA DETECT 2, set the brightness for the zebra patterns. (Page 109)

The zebra pattern you have set appears as a percentage on the display for about 2 seconds.

Marker

If you press the ZEBRA button again while the zebra pattern is being displayed, a marker appears in the center of the display (if you have set the setup menu, DISPLAY SETUP, MARKER to ON).

The brightness of the areas near the screen center can be checked as a percentage (0% to 99%).

"99%↑" appears if the percentage is over 99.

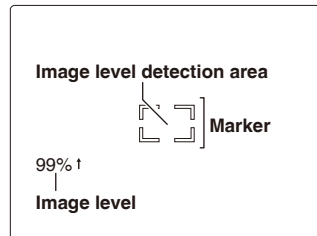

The normal display reappears if you press the ZEBRA button again.

Shooting techniques for different targets (continued)

Checking and displaying shooting status

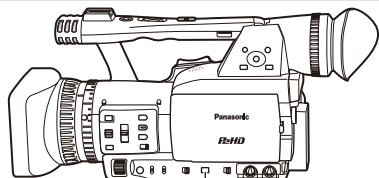

DISP/MODE CHK button

When you hold down the DISP/MODE CHK button during recording standby or recording, all the information including the setting status of the shooting functions and a list of functions allocated to the USER buttons, will be displayed. When you release the button, the normal display will be restored.

When you push the DISP/MODE CHK button during recording standby or recording, all the information will be unshown. When you press the button again, the normal display will be restored. The information is retained even if you turn off the unit's power or switch to another operation mode.

To display property of the selected clip in MCR mode, press the DISP/MODE CH button in the thumbnail screen. Press the button again to return to the thumbnail screen.

Changing the image size

When recording in 576i (480i) mode, you can change the size (aspect ratio) of the images that you record.

Select the aspect ratio in the setup menus, CAMERA SETUP screen, ASPECT CONV. (Page 101)

- For menu operation (Page 95)

SIDE CROP:

Recorded in the regular 4:3 aspect ratio.
The left and right edges of the image are cut.



LETTER BOX:

Recorded in the 16:9 aspect ratio.
Black bands are recorded at the top and bottom of the image.



SQUEEZE:

The recorded images are squeezed horizontally so that they are shown as 16:9 images on a compatible wide-screen television.
If you have selected SQUEEZE, "SQU" appears on the screen.



To change the aspect ratio display of the viewfinder and LCD

Select the aspect ratio in the setup menus, DISPLAY SETUP screen, DISPLAY ASPECT. (Page 110)

Optical Image Stabilizer

Use the Optical Image Stabilizer (OIS) to reduce the effects of camera shake when shooting by hand.

Press the OIS button to turn the function on and off.

 appears on the screen when this function is on. Turn the function off when using a tripod for more natural images.

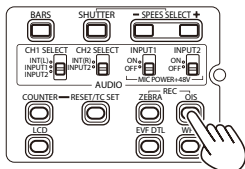

- This function will not be as effective when the vibration is severe or when tracking a moving subject.

Adding effects to images

Press the USER button you have allocated to the BLACKFADE or WHITEFADE feature to add fading effects to your images. The button's function is forcibly canceled during playback or REC CHECK and also when thumbnails are displayed.

BLACKFADE:

Press and hold to fade out to black. Audio also fades out. Fade-in starts when the button is released.

WHITEFADE:

Press and hold to fade out to white. Audio also fades out. Fade-in starts when the button is released.

Using the USER buttons

You can allocate one of sixteen features to each of the three USER buttons.

Use these buttons to change shooting settings quickly or add effects to the images you are shooting.

The following features are allocated to the buttons at the time of shipping.

USER1: WHITEFADE

USER2: BACKLIGHT

USER3: TEXT MEMO

For details, see the setup menus, SW MODE screen, USER1 to 3. (Page 103)

If you press a USER button to which one of the following functions has been allocated and then turn off the power, that button will revert to the previous setting:

SPOTLIGHT, BACKLIGHT, ATW, ATW LOCK, GAIN:18 dB, D.ZOOM

Backlight compensation

Press the USER button you have allocated to the BACKLIGHT feature when shooting subjects lit from the back.

BACK appears on the screen.

Backlight compensation adjusts the iris so the subject doesn't come out dark.

Press the same USER button to turn the feature off.

Color bars

Press the BARS button in CAM mode to output a color bar screen to a television or monitor so you can adjust them.

Press the button again to turn the feature off.

A 1 kHz test tone is output in the color bar screen when ON is selected under TEST TONE on the setting menu AV IN/OUT SETUP screen.

- The color bar can be recorded together with a 1 kHz test tone.

Shooting techniques for different targets (continued)

Waveform monitor function

Press the WFM button in CAM mode to display a waveform of the image on the LCD monitor.

Pressing the WFM button once again closes the waveform display.

- WFM (Page 104) on the setting menu SW MODE screen allows you to switch between the waveform and vector display.
- The viewfinder does not show the waveform display.
- The waveform does not appear when the focus assist function is used.
- The waveform display cannot be recorded.

Adjusting the volume while shooting

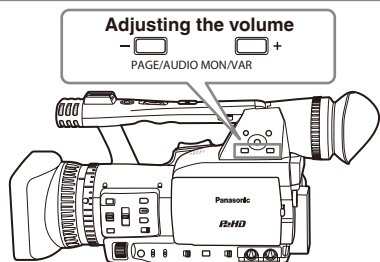

If you are monitoring the sound through headphones while shooting, you can adjust the volume with the PAGE/AUDIO MON/VAR button.

- To adjust the recording level (Page 53)

Backup recording

If you have connected equipment to the 1394 terminal (Pages 78 and 79), you can make automatic backup recordings of whatever you are shooting.

- In the setup menus, OTHER FUNCTIONS screen, 1394 CONTROL and 1394 CMD SEL, select how to control the equipment you have connected. (Pages 112)

Note the following when backup recording.

- Menu settings are retained even if you turn the power off. So if you use the camera-recorder with the settings for backup recording still in effect, images on media in any unit that connected may be overwritten. After backup recording, check the menu item settings before you operate the camera-recorder.
- If you use another AG-HPX171E as the external unit for backup recording, select "OFF" for 1394 CONTROL on the external unit and set it to MCR mode.
- Backup recording may not work properly if you connect two or more external units.
- Use a 1394 cable of 4.5 m or less for connection.
- Set the external unit up to receive 1394 signals before backup recording.
- You can have a media in the external unit start recording automatically when the media in this unit is almost finished. Set 1394 CONTROL on the setting menu OTHER FUNCTIONS screen (Page 112) to "CHAIN".
- Note that images are recorded even when you perform a rec check.
- You cannot perform backup recording when the unit is set up for native recording.
- Backup recording does not work in three of the special recording modes: Interval recording, One-shot recording and Loop recording (Pages 47 – 49)
- Backup recording does not work during direct shooting (Page 67) in MCR mode.

2-slot continuous recording

If you insert two P2 cards into the two card slots, this function allows you to record continuously on the two cards.

You can also record continuously on three or more cards by replacing one card while data is being recorded on the other. (Hot swap recording) However, depending on when the P2 card is inserted into an empty slot (immediately after pre-recording, or before or after continuous recording spanning two slots), there may be a delay in recognizing the P2 card. We recommend inserting the P2 card while there is at least one minute remaining on the card that is recording.

The SLOT SEL button offers a one-touch mechanism to select the slot whose card will be recorded.

- You cannot change slots while recording so do this during recording standby.
- Does not support hot swap playback.

Shot mark function

The marks attached to the thumbnails of clips are called shot marks. On the thumbnail screen monitor you can select only those clips with a shot mark and display them or play them back.

During recording, when you press the USER button to which the SHOT MARK function has been allocated, MARK ON appears in the LCD monitor or the viewfinder, and a shot mark is set for the thumbnail of the clip being recorded. If you press the button again, the shot mark is released.

You can also set or release the shot marks by performing the thumbnail operations for clips. (Page 67)

However, note that you cannot set or release shot marks during playback.

- INVALID appears when you cannot set or release shot marks.
- When the video data of a single shoot using hot swap recording is made up of multiple clips, you cannot set or release shot marks unless all the P2 cards that make up the video data are inserted into the slots.
- You cannot set or release shot marks during loop recording.

Text memo recording

This function adds text memos at the video points on the clip now being recorded or played back.

When you press the USER button to which the TEXT MEMO function has been allocated, the text memo will be recorded at that point. (Page 43) On the thumbnail screen you can select only those clips where text memos have been added, and then either display those clips or play them back. You can record up to a hundred text memos per clip.

You will need the latest updated version of P2 Viewer to edit the text memos. (Page 123)

- You cannot record text memos during interval recording or one-shot recording.
- INVALID appears when you cannot record text memos.

Time stamp function

Use the time stamp function to record date and time of shooting on the video.

Select ON under TIME STAMP on the setting menu RECORDING SETUP screen.

“[R]” prefixes the date and time display in the viewfinder and the LCD monitor when the time stamp function is on.

- “[R]” is not recorded on the video.
- The size and location of the date and time characters will vary with the recording format.
- The data recorded depends on the DATE/TIME setting on the setting menu DISPLAY SETUP screen. No data is recorded when OFF is selected.
- Superimposed characters are output only during 1394 output.

Shooting techniques for different targets (continued)

LAST CLIP DELETE function

Assign LAST CLIP to any of the USER 1 – 3 buttons to enable a convenient way to delete the last recorded clip.

Pressing the USER button to which LAST CLIP was assigned displays a YES/NO confirmation dialog on the screen.

Select YES, and the last recorded clip is deleted and "LAST CLIP DELETE OK" is displayed.

- Select NO to cancel clip deletion.
- Clips cannot be deleted when a switch has been made to the MCR or PC mode or the recording format has been changed after completing a recording. Then it will not be possible to delete the clip by turning the power off and turning it back on.
- This button cannot be used to delete clips when a P2 card (one of two inserted cards) has been removed and reinserted after recording, nor can it be used to delete clips on a write-protected P2 card.
- In hot swap recording, the clip delete function is not available unless all the P2 cards containing data shot in one recording operation are inserted.
- The YES/NO confirmation dialog does not appear when the clip delete function is not available.

Using the special recording functions

Making the settings in the RECORDING SETUP screen (Page 105) enables special recording functions such as **Pre-recording**, **Interval Recording**, **One Shot Recording**, and **Loop Recording**.

These special recording functions can be used only when the settings below are established.

- **OPERATION TYPE** item (Page 99): VIDEO CAM
- **Recording format:**
 - When SYSTEM FREQ is set to 50 Hz
1080i/50i, 720P/50P, 576i/50i, 1080i/25P, 720P/25P or 576i/25P
 - When SYSTEM FREQ is set to 59.94 Hz
1080i/60i, 720P/60P, 480i/60i, 1080i/30P, 720P/30P or 480i/30P

Pre-recording (PRE REC)

This function is used to record pictures and sound starting at a fixed time (approx. 3 seconds for HD recording or approx. 7 seconds for 576i (480i) recording) before the time when the actual recording has been set to start.

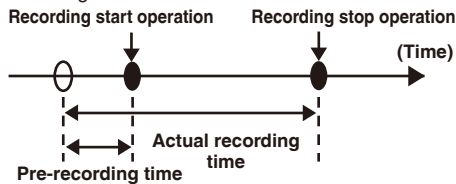

1 Check that the settings given above have been established for the OPERATION TYPE item and recording format.

2 Select ON under PREREC MODE. (Page 105)

- For menu operations (Page 95)

3 Press the START/STOP button. Pre-recording starts.

- In the following cases, the pre-recording function will be canceled, and recording will be initiated from the respective operation points.
 - When 1394 input recording is initiated
 - When the unit is transferred from the playback mode to the recording mode
 - When interval recording is initiated
 - When one-shot recording is initiated
 - When loop recording is initiated
- Immediately after switching from the MCR mode to CAM mode, immediately after turning on the camera-recorder's power or immediately after changing the PRE-REC option setting, it may not be possible to record the images and sound before the time mentioned on the previous page has elapsed even if the recording has been started straight away.

Interval recording (INTERVAL REC)

With this function, the unit continuously records frames (1/25 (1/30) sec.) one at a time with an interval.

The interval can be set with INTERVAL TIME item.

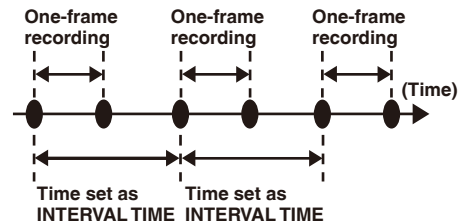

1 Check that the settings given above have been established for the OPERATION TYPE item and recording format.

2 Select INTERVAL under REC FUNCTION. (Page 105)

- For menu operations (Page 95)

3 Set the time INTERVAL TIME. (Page 105)

4 Press the START/STOP button.

The unit starts INTERVAL REC operation.

- To stop operation, push the Operation lever in the **■** direction.
- To release the function, either turn off the unit's power or select NORMAL under REC FUNCTION.
- The following displays will appear on the left of the operation status display.
 - While recording is underway: I-REC lights up.
 - In temporary standby: I-PAUSE lights up.
 - While recording is stopped: The "I-" of I-PAUSE flashes.
- However, if the duration selected in step 3 is less than 2 seconds, I-REC will flash while recording is underway in accordance with the set time.
- The pre-recording function does not work.

(Continued on the next page)

Using the special recording functions (continued)

- No sound is recorded.
- All data recorded while this mode is active will be contained in one file.
- No guarantees are made for the 1394 output images.
- Operation is not possible even if only one of the inserted cards is DIR ENTRY NG CARD. (Page 92)
- After interval recording has started, a recordable P2 card cannot be used even if it is inserted into an empty slot.
- The slots for recording in this mode are indicated by the orange P2 card access lamps.
The slots for recording P2 cards that are inserted after starting recording are indicated by the green P2 card access lamps.
- Text memos cannot be added.
- No guarantees are made for the 1394 output images.
- Operation is not possible even if only one of the inserted cards is DIR ENTRY NG CARD. (Page 92)
- When continuous one-shot recording is performed, there may be delays in acknowledging the recording operation.
- After one-shot recording has started, a recordable P2 card cannot be used even if it is inserted into an empty slot.
- The slots for recording in this mode are indicated by the orange P2 card access lamps.
- The slots for recording P2 cards that are inserted after starting recording are indicated by the green P2 card access lamps.
- Text memos cannot be added.

One-shot recording (ONE-SHOT REC)

This function records a single shot at each unit of time which has been set.

1 Check that the settings given on Page 47 have been established for the OPERATION TYPE item and recording format.

2 Select ONE SHOT under REC FUNCTION. (Page 105)

- For menu operations (Page 95)

3 Set the recording time using ONE-SHOT TIME. (Page 105)

4 Press the START/STOP button.

Recording continues for the duration set in step 2 and then goes on standby.

To stop operation, push the Operation lever in the **■** direction.

To release standby, either turn off the unit's power or select NORMAL under REC FUNCTION.

- The following displays will appear on the left of the operation status display.
While recording is underway: I-REC lights up.
In temporary standby: I-PAUSE lights up.
While recording is stopped: The "I-" of I-PAUSE flashes.
- The pre-recording function does not work.
- No sound is recorded.
- All data recorded while this mode is active will be contained in one file.

Loop recording (LOOP REC)

This function is used to record first on one card and then on the next when you have inserted two P2 cards into the card slots. If there is not enough free memory remaining on the second card, recording returns to the first card whose data will then be overwritten. When data is overwritten, the saved clips are deleted, and then the new clips are recorded in their place. (Clip deletion is performed approximately 30 seconds before the overwrite.)

1 Check that the settings given on Page 47 have been established for the OPERATION TYPE item and recording format.

2 Select LOOP under REC FUNCTION. (Page 105)

- For menu operations (Page 95)

3 Press the START/STOP button.

Recording starts.

To stop operation, press the START/STOP button.

To release the function, either turn off the unit's power or select NORMAL under REC FUNCTION.

- The following displays will appear on the left of the operation status display.
While recording is underway: L-REC lights up.
While recording is stopped: L-PAUSE lights up.
Insufficient memory space: LACK L- flashes.

-
- Use two P2 cards each with a recording capacity of more than one minute. Recording stops when either card is ejected.
 - This function does not work during 1394 input recording.
 - The pre-recording function does not work.
 - Operation is not possible even if only one of the inserted cards is DIR ENTRY NG CARD. (Page 92)
 - Stopping may take some time.
 - The following operations are not acknowledged until the P2 card access lamps change from blinking to fully lit up.
 - The slots for recording in this mode are indicated by the orange P2 card access lamps.
 - Text memos cannot be added.

Adjusting the shutter speed

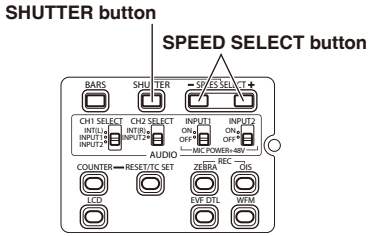

- Remember that the faster the shutter speed, the lower the sensitivity.
- If iris is set to auto, then it will open wider with higher shutter speeds and thereby reduce focal depth.
- It will take longer to focus when the shutter speed has been reduced so it is recommended that the unit be secured to a tripod, etc. for use.

1 Press the SHUTTER button.

Each time you press the SHUTTER button, the shutter speed switches between normal (OFF) and the speed you selected with the SPEED SELECT button.

2 After you have pressed the SHUTTER button, press SPEED SELECT to select the shutter speed.

The shutter speed changes as follows each time you press SPEED SELECT + (The order is reversed for the SHUTTER SELECT - button.)

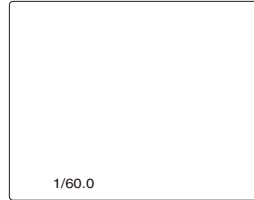

The current shutter speed appears on the viewfinder and LCD screens unless you have selected OFF in OTHER DISPLAY in the DISPLAY SETUP screen of the setup menus. It is not displayed if you have set the shutter speed to normal (OFF).

When SYSTEM FREQ is set to 50 Hz

With the 1080i/50i, 720P/50P and 576i/50i formats	
Standard (Off) 1/50	SYNCRO SCAN ↔ <u>1/12</u> ↔ <u>1/25</u> ↔ 1/60 ↔ 1/120 ↓ ↓ 1/2000 ↔ 1/1000 ↔ 1/500 ↔ 1/250
With the 1080i/25P, 720P/25P, 576i/25P and 720P/25PN formats	
Standard (Off) 1/50	SYNCRO SCAN ↔ <u>1/12</u> ↔ 1/25 ↔ 1/60 ↓ ↓ 1/1000 ↔ 1/500 ↔ 1/250 ↔ 1/120

When SYSTEM FREQ is set to 59.94 Hz

With the 1080i/60i, 720P/60P and 480i/60i formats	
Standard (Off) 1/60	SYNCRO SCAN ↔ <u>1/15</u> ↔ <u>1/30</u> ↔ 1/100 ↓ ↓ 1/2000 ↔ 1/1000 ↔ 1/500 ↔ 1/250 ↔ 1/120
With the 1080i/30P, 720P/30P, 480i/30P and 720P/30PN formats	
Standard (Off) 1/50	SYNCRO SCAN ↔ <u>1/15</u> ↔ 1/30 ↔ 1/60 ↓ ↓ 1/1000 ↔ 1/500 ↔ 1/250 ↔ 1/120
With the 1080i/24P, 480i/24P, 1080i/24PA and 480i/24PA formats	
Standard (Off) 1/50	SYNCRO SCAN ↔ 1/24 ↔ 1/60 ↓ ↓ 1/1000 ↔ 1/500 ↔ 1/250 ↔ 1/120
With the 720P/24P and 720P/24PN formats	
Standard (Off) 1/50	SYNCRO SCAN ↔ <u>1/12</u> ↔ 1/24 ↔ 1/60 ↓ ↓ 1/1000 ↔ 1/500 ↔ 1/250 ↔ 1/120

* **Bold** and underlines indicate formats that can be selected only when VIDEO COM is selected under OPERATION TYPE, and OFF is selected under DRS in the SCENE FILE screen of the setup menus.

With artificial lighting and especially fluorescent lights and mercury-vapor lamps, the luminance changes in synchronization with the power line frequency. When this frequency is 50 Hz, mutual interference will occur between the camerarecorder's vertical sync frequency (approx. 60 Hz) and the lighting frequency (50 Hz). This means that the white balance may change periodically.

Before shooting in areas with artificial lighting or adjusting the white balance, set the shutter speed as follows.

When SYSTEM FREQ is set to 50 Hz

Progressive mode	Shutter speed	
	50 Hz	60 Hz
OFF (50i)	1/60	OFF (1/50)
25P/25PN	OFF (1/50)	1/60

- The gain is fixed at 0 dB with a shutter speed of 1/12.

When SYSTEM FREQ is set to 59.94 Hz

Progressive mode	Shutter speed	
	50 Hz	60 Hz
OFF (60i)	1/100	OFF (1/60)
30P	OFF (1/50)	1/60
24P/24PA/ 24PN	OFF (1/50)	1/60

- The gain is fixed at 0 dB with a shutter speed of 1/12 and 1/15.

Synchro scan

Set the shutter speed of the synchro scan (used when shooting a television or computer monitor) in the setup menus, SCENE FILE screen, SYNCRO SCAN. (Page 99)

- Adjust the shutter speed to match the frequency of the television or computer monitor to minimize the horizontal noise that appears when shooting such subjects.
- When SYSTEM FREQ is set to 59.94 Hz, by switching to progressive mode you can also shoot PAL system television screens.
- When the OPERATION TYPE option in the SCENE FILE screen (Page 99) is set to FILM CAM, the shutter opening angle can be adjusted from 10° to 360° in 0.5° steps.

Example: When the recording frame rate is set to 25 (24) fps and the exposure time is halved, $1/25 (1/24) \div 2 = 1/50 (1/48) = 180^\circ (1/25 (1/24) = 360^\circ)$ In the default setting (180°), this becomes 1/2 of the exposure time. If it were 90°, it would be 1/4, and if it were 45°, it would be 1/8 of the exposure time.

(Shutter opening angle: This is equivalent to the shutter speed of a film camera, and a wider angle results in a longer exposure to light.)

- If the shutter speed is displayed in blue characters followed by (1/50 (1/60)), you cannot change the shutter speed in the blue characters while the current recording format is used. The speed is fixed at (1/50 (1/60)).
- A change under SYSTEM FREQ resets the camera to its factory settings.

You can change the progressive mode in the setup menu with REC FORMAT in the RECORDING SETUP screen. (Page 105)

Switching Audio Input

During shooting, you can record up to four channels of sound. You can also switch the input sound to be recorded on each of the channels to the built-in microphones, external microphones or audio equipment connected to camera. (See table below)

CH1*	CH2**	CH3	CH4
INT(L): Built-in microphone L	INT(R): Built-in microphone R	INPUT1	INPUT2
INT(L): Built-in microphone L	INPUT2	INPUT1	INT(R): Built-in microphone R
INPUT1	INT(R): Built-in microphone R	INT(L): Built-in microphone L	INPUT2
INPUT1	INPUT2	INT(L): Built-in microphone L	INT(R): Built-in microphone R
INPUT2	INPUT2	INT(L): Built-in microphone L	INT(R): Built-in microphone R
INPUT2	INT(R): Built-in microphone R	INT(L): Built-in microphone L	INPUT2

* The input sound to be recorded onto CH1 can be switched using the CH1 SELECT switch.

** The input sound to be recorded onto CH2 can be switched using the CH2 SELECT switch.

- The CH3 and CH4 input sound is determined automatically by what was selected using the CH1 SELECT switch and CH2 SELECT switch. However, the following restrictions apply depending on the media and format used. (Page 125, Recording format)

When the DVCPRO HD or DVCPRO50 format is used:

The recording mode is fixed at 4-channel recording.

When the DVCPRO25 or DV format is used:

Either 2 or 4 channels can be selected using 25M REC CH SEL on the setting menu RECORDING SETUP screen.

Using the built-in microphone

- 1 Switch the CH1 SELECT switch to INT (L).**
 - Audio from the built-in microphone Lch is recorded to audio channel 1.
- 2 Switch the CH2 SELECT switch to INT (R).**
 - Audio from the built-in microphone Rch is recorded to audio channel 2.

Using another microphone and audio equipment

- 1 Connect an external microphone or audio equipment to the INPUT 1/2 (XLR 3-pin) terminal. (Page 77)**
- 2 Use the INPUT 1/2 switch to switch the audio input.**

LINE: (audio equipment is connected)
Input level is 0 dBu.

MIC: (another microphone is connected)
Input level is -50 dBu.

You can change the input level to -60 dBu in the setup menus, RECORDING SETUP screen MIC GAIN 1 and MIC GAIN 2 (Page 106). Be aware that sensitivity will be higher if you choose -60 dBu so you will record more noise.

- 3 When using the phantom microphone,** set the INPUT 1/2 (MIC POWER +48V) switch to ON.

ON: (When using the phantom microphone) +48V power supply to INPUT 1/2 terminal.

OFF: (When a phantom microphone is not connected)
No power supply for INPUT 1/2 terminal.

 - The battery will discharge faster if you use a phantom microphone.
 - Set to OFF if you connect equipment not compatible with +48V. You can damage such equipment if you leave the setting at ON.

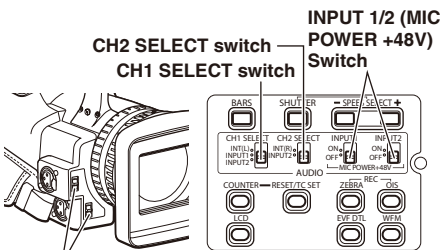

INPUT 1/2 switches

- 4 Use the CH1 SELECT switch to select the input signal to be recorded to audio channel 1.**

INT (L):

Audio from the built-in microphone Lch is recorded to audio channel 1.

INPUT 1:

Audio from a device connected to INPUT 1 terminal is recorded to channel 1.

INPUT 2:

Audio from a device connected to INPUT 2 terminal is recorded to channel 1.

- 5 Use the CH2 SELECT switch to select the input signal to be recorded to audio channel 2.**

INT (R):

Audio from the built-in microphone Rch is recorded to audio channel 2.

INPUT 2:

Audio from a device connected to INPUT 2 terminal is recorded to channel 2.

- When inputting the microphone signal to channels 1 and 2, connect the microphone to INPUT 2 and switch both CH1 SELECT and CH2 SELECT to INPUT 2.

Adjusting the recording level

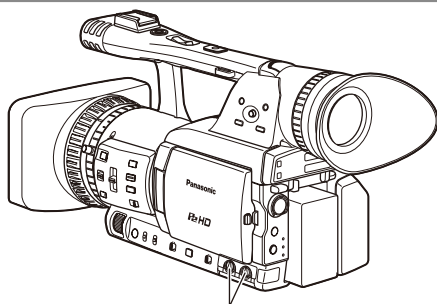
**AUDIO LEVEL knob**

Use the AUDIO LEVEL knob to adjust the recording level of the built-in microphone or of audio signals input through the INPUT 1/2 (XLR 3-pin) terminal.

To adjust the volume of the sound for monitoring. (Page 44)

To adjust the recording level of the audio signals, turn the AUDIO LEVEL knob while referring to the audio level meter at the bottom left of the viewfinder and LCD monitor, regardless of the MIC ALC option setting (Page 106) on the RECORDING SETUP screen of the setting menu.

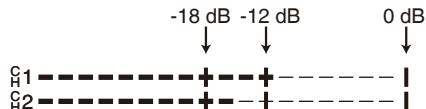
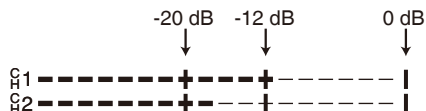
When SYSTEM FREQ is set to 50 Hz**When SYSTEM FREQ is set to 59.94 Hz**

- The CH1 and CH2 characters are highlighted (they will appear in black text) when INT MIC on the AV IN/OUT SETUP screen is set to OFF.

CH1
CH2

INT MIC ON

CH1
CH2

INT MIC OFF

Check the recording level prior to shooting.

- The recording level is set higher than for Panasonic's broadcast-use camera recorders (AJ series).

Using scene files

The settings according to the variety of shooting circumstances are stored in each position of scene file dial.

When shooting, you can retrieve the necessary file instantly using scene file dial.

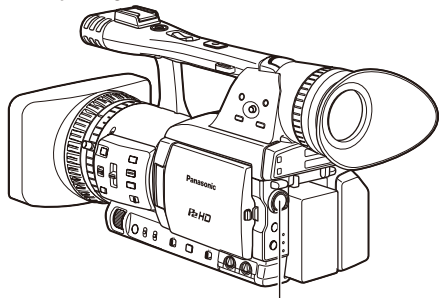

Scene file dial

- During recording, the OPERATION TYPE and FRAME RATE (Page 99) settings remain unchanged even when the scene file is changed. To change these settings, set the camerarecorder to recording standby state.

When the camera-recorder is shipped from the factory, the following files are stored.

F1: SCENE

File suitable for normal shooting.

F2: SCENE FLUO.

File suitable for shooting under fluorescent lights, ie. indoors.

F3: SCENE SPARK

File suitable for shooting with fuller variations of resolution, coloring and contrast.

F4: SCENE B-STR

File for broadening the contrast of dark parts, such as when shooting sunsets.

F5: SCENE CINE V

File suitable for shooting movie-like scenes where the contrast is to be emphasized. (The recording format remains unchanged even when the scene file is changed. It must be set using the REC FORMAT option on the RECORDING SETUP screen. (Page 105))

F6: SCENE CINE D

File suitable for shooting movie-like scenes where the dynamic range is to be emphasized. (The recording format remains unchanged even when the scene file is changed. It must be set using the REC FORMAT option on the RECORDING SETUP screen. (Page 105))

Changing scene file settings

The setting value of the scene file can be changed. Also you can save the changed scene file to each position of the scene file dial.

Example: Change the name of the scene file.

- 1 Set the POWER switch to ON.
- 2 Turn the scene file dial, then select the scene file to be changed.
- 3 In the setup menus, select the SCENE FILE screen.
 - For menu operation (Page 95)
 - You can also use the menu buttons on the remote control. (Page 14)
- 4 Push the Operation lever in the ▲ or ▼ direction to select NAME EDIT.

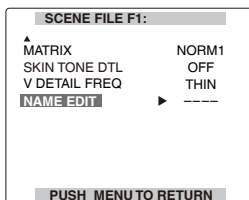

- 5 Press the Operation lever (or push it in the ► direction), then push it in the ▼ direction to select YES and press it again.

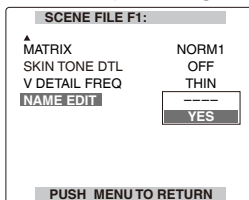

6 When the screen shown below appears, use the Operation lever to enter a 6-character file name.

Set the same as user information. (Page 62)

- Characters that can be set

Space, A to Z, 0 to 9, ; < = > ? @ [\] ^ _ - /

When the filename has been set, you can erase all characters using the RESET button on the camera or the remote control.

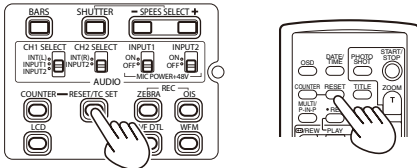

Camera or Remote control

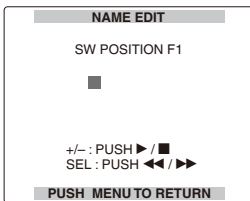

7 After you finish setting the filename, press the MENU button.

8 Push the Operation lever in the ▼ direction to select LOAD/SAVE/INIT.

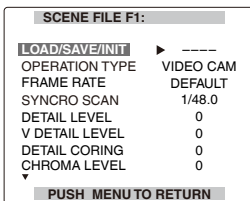

9 Press the Operation lever, push it in the ▼ direction to select SAVE and press it again.

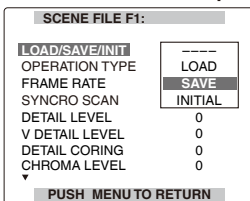

10 Press the Operation lever to select YES when the screen shown below appears.

(To return to the menu level above, press the MENU button.)

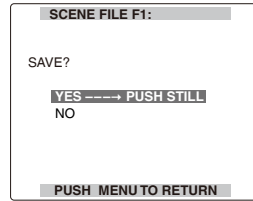

The message below appears, and the changes to the scene file are complete.

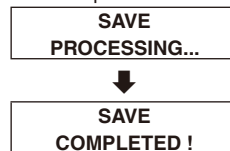

11 Press MENU twice to exit the menus.

- To return to a previously saved setting after a change in scene file settings, select LOAD in step 9 and do steps 10 and 11.
- To return the scene file settings to the factory settings, select INITIAL in step 9, then do steps 10 to 11.

Saving scene files and other settings on SD memory cards

You can save up to four scene file settings or other settings as files on an SD memory card, and you can also load them from the card.

- The data in all the scene files, F1 to F6, is rewritten.
- Insert the SD memory card into the unit.
(Page 29)

If you have saved a scene file

1 Set the unit's POWER switch to ON.

2 Select **SCENE FILE** on the setting menu **CARD FUNCTIONS** screen, select **YES** and press the Operation lever. (or push it in the ► direction)

For all other settings, select USER FILE.

- For menu operations (Page 95)
- You can also use the menu buttons on the remote control. (Page 14)

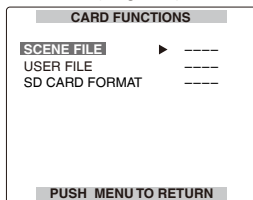

3 Push the Operation lever in the ◀ or ▶ direction to select a file number (1 to 4).

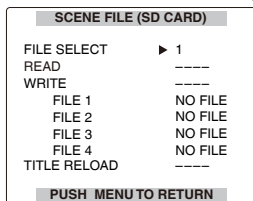

4 Push the Operation lever in the ▲ or ▼ direction to select **WRITE** and press it again.

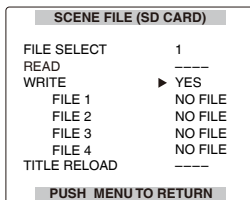

5 Push the Operation lever in the ◀ direction to display the screen below, then select **YES** and press the Operation lever again.

- In the following example, TITLE 1 is the filename. (To change the filename, see page 57.)

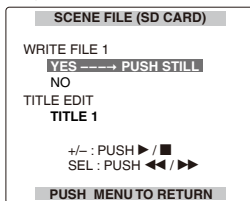

The message shown below appears to indicate that the change in scene file settings has been completed.

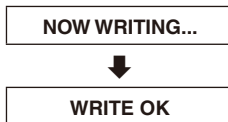

6 Press the MENU button four times to cancel the menu mode.

To load a file

- 1) Perform steps 1 to 3, select READ in step 4 and push the Operation lever.
When reading is completed, READ OK appears.

To title a file

- 1) Perform steps 1 to 4.
- 2) Push the Operation lever in the ▲ or ▼ direction to select a character, then push it in the ► direction to move to the next character. (The next character can now be selected.)
 - You can input any of the following characters:
Space, A to Z, 0 to 9, ; : < = > ? @ [\] ^ _ - /
 - You can erase all characters using the RESET button on the camera or the remote control.

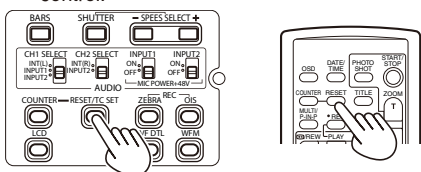

Camera or Remote control

- 3) When all characters have been entered, push the Operation lever in the ◀ direction at the left end (or in ► direction at the right end) of the characters. Then press the Operation lever.

To reload a file from an SD memory card

- 1) Perform steps 1 and 2.
- 2) Push the Operation lever in the ▲ or ▼ direction to move to TITLE RELOAD, display YES and press it again.
The file reloads.

-
- If WRITE NG FORMAT ERROR appears, format the SD memory card. (Page 29)
 - If WRITE NG WRITE PROTECT appears, release the protected status of the SD memory card.
 - If WRITE NG CANNOT ACCESS appears, quit all other operations (such as playback) before proceeding.
 - If WRITE NG ERROR appears, the SD memory card may be defective. Replace it.
-

Clip metadata

You can add the video and audio systems, name of the videographer, shooting location, text memos and other information to the video data you have recorded on the P2 card. This data is called the clip metadata. (Display method: Page 70)

There are two kinds of clip metadata: the data that is recorded automatically during shooting, and the data in the metadata upload file created on the SD memory card which is loaded in the unit. (Loading method: Page 73)

Creating the metadata upload file on the SD memory card

You will need the latest updated version of P2 Viewer. Download it from the URL address given below, and install it in the computer.
<https://eww.pavc.panasonic.co.jp/pro-av/>

What the clip metadata consists of

You can set the items underlined below by loading the metadata upload file on the SD memory card. All other items are set automatically during shooting.

GLOBAL CLIP ID:

This indicates the global clip ID that shows the shooting status of the clip.

USER CLIP NAME:

This indicates the name of the clip that the user has set.*1

VIDEO:

This indicates the recorded image's FRAME RATE, PULL DOWN system and ASPECT RATIO.

AUDIO:

This indicates the recorded sound's SAMPLING RATE (sampling frequency) and BITS PER SAMPLE (number of quantizing bits).

ACCESS:

This indicates the CREATOR (name of the person recording), CREATION DATE (recording date), LAST UPDATE DATE (date on which the data was last updated), and LAST UPDATE PERSON (the person who last updated the data).

DEVICE:

This indicates the MANUFACTURER (manufacturer of the equipment), SERIAL NO. (serial number of the equipment) and MODEL NAME (equipment model name).

SHOOT:

This indicates the SHOOTER (name of the videographer), START DATE (date and time at which shooting started), END DATE (date and time at which shooting ended) and LOCATION/ALTITUDE/LONGITUDE/LATITUDE/SOURCE/PLACE NAME (shooting location, altitude, longitude, latitude, information source, name of location).

SCENARIO:

This indicates the PROGRAM NAME, SCENE NO. and TAKE NO.

NEWS:

This indicates the REPORTER (name of the reporter), PURPOSE (purpose of data collection) and OBJECT (target of data collection).

MEMO: *2

This indicates the No. (memo No.), OFFSET (frame position from the beginning of the clip), PERSON (name of the person who recorded the text memo), and TEXT (contents of memo).

THUMBNAIL:

Indicates thumbnail image offset.

It is used in editing thumbnails with the EXCH. THUMBNAIL function.

*1 If there is no information in the metadata upload file, the global clip ID serves as the USER CLIP NAME. The USER CLIP NAME recording method is selectable. Please refer to Appendix (Page 126).

*2 When MEMO is to be input, you must input TEXT. You cannot input PERSON only.

-
- It may not be possible to load files which have been edited using a viewer other than the P2 Viewer. (In this case, UNKNOWN DATA will be displayed.)
 - Only printable ASCII characters can be displayed by this unit.
 - Due to the limitations imposed by this unit on the number of characters which can be displayed, not all the data can be displayed. (This does not mean that the data which is not displayed has been deleted.) Use a P2 viewer or other program to check all the data.
-

Using the Counter

Counter display

You can display a counter that indicates how much time has elapsed during shooting or playback.

1 Press the COUNTER button.

Each time you press the button, the display changes as follows. (Page 88)

0 : 00. 00 (CAM mode only)

Counter value

CLIP 0 : 00. 00

(When CLIP is selected for the REC COUNTER item on the DISPLAY SETUP screen)

The value is automatically reset at start of shooting and the counter value appears during each shooting session.

TC XX:XX:XX:XX

Time code value (When SYSTEM FREQ is set to 50 Hz, display time code frame digits in 25 frames. When SYSTEM FREQ is set to 59.94 Hz, display time code frame digits in 24 frames when 720/24PN is set, and in 30 frames when any other format is set.)

tc XX:XX:XX:XX

(Only in 59.94 Hz FILM CAM mode)

During recording and playback when FILM CAM has been set under OPERATION TYPE, the time code frame digits are converted into 24 frames for display. However, "tc" does not appear during recording when 720/24PN has been set under REC FORMAT, or during recording and playback when 720/30PN has been set. During playback when 720/24PN has been set, the time code frame digits are converted into 30 frames for display. (Pages 99 and 105)

UB XX XX XX XX

User information

FR --- -

Frame rate (25P(30P/24P/24PA)) and frame sequence in progressive mode shooting.

No display:

Data is not displayed.

Resetting the counter

Press the COUNTER RESET button while the counter is displayed.

1394TC preset mode

When shooting using a multi-camera, you can synchronously set the initial values of TC. The camera used for synchronization is the MASTER and the camera being synchronized is the SLAVE.

1 Connect a second camera with a 1394 cable and turn both cameras on.

- For connection (Page 79)

2 Put the MASTER camera in CAMERA mode and output a video signal from the 1394 terminal.

- Set both cameras to the same recording format.

Do the remaining steps on the SLAVE camera.

3 Switch the SLAVE camera to MCR mode, set 1394TC REGEN on the RECORDING SETUP screen of the setup menu to OFF and then set the counter so that it shows the TCG display.

- You cannot do this if you have selected REGEN.

4 In the setup menus, RECORDING SETUP screen, set 1394 IN PRESET to ON. (Page 107)

- 1394TC appears on the screen.

5 Stop the media.

6 Press the COUNTER RESET/TC SET button. The TCG value is preset with the TC value from the input 1394 signal.

- "TC SET OK" is displayed for about 2 seconds in the center of the screen.

7 Reset the SLAVE camera to CAMERA mode.

Charging the built-in battery/Setting the time data

Recharging the built-in battery

The camera's internal battery saves the date and time. "🔋" appears on the screen of the viewfinder or LCD when the internal battery is running low on charge.

Do the following to recharge it.

Reset the date and time when fully recharged.

1 Connect the AC adapter. (Page 16)

- Leave the POWER switch at OFF.

2 Leave the camera-recorder like this for about 4 hours.

- The internal battery charges during this time.
- Recharge the battery regularly to ensure correct TC and menu operations.

If "🔋" appears even after charging, it means that the internal battery must be replaced. Ask your dealer to do this.

Setting the time code

In the setup menus, RECORDING SETUP screen, set the following time code related items. (Page 106)

- **TC MODE**
- **TCG**
- **TC PRESET**
- **1394 TC REGEN** (appears when in MCR mode)

In MCR mode and 1394 TC REGEN is ON, you cannot change the items shown above.

Specifying the time code (TC PRESET)

Set TC PRESET so you can record a value of your choice as the initial setting for the time code to be used at the start of recording.

1 Set the POWER switch to ON.

2 On the setting menu RECORDING SETUP screen, push the Operation lever in the ▲ or ▼ direction to move to TC PRESET and press it again.

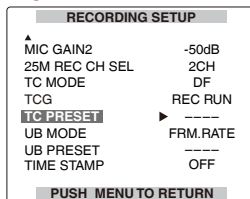

3 Push the Operation lever in the ▼ direction to move to YES and press it again.

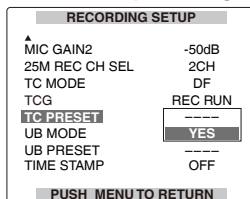

4 When the screen below appears, set the time code value.

Push the Operation lever in the ▲ or ▼ direction to select a time code value.

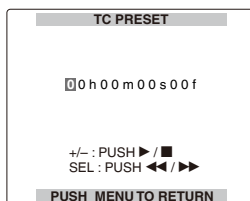

Push the Operation lever in the ► direction to move to the next digit, then push it in the ▲ or ▼ direction to select a value.

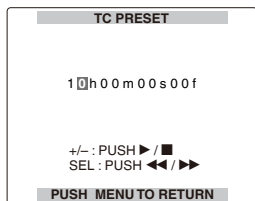

You can reset the time code to zero by pressing RESET on the camera or the remote control.

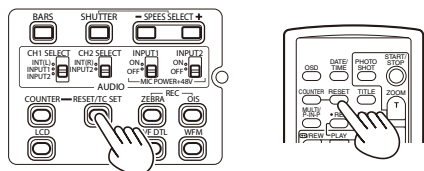

Camera or Remote control

- 5** Press the MENU button when you have finished setting the time code.



- 6** Push the Operation lever in the ▲ direction to move to YES and press it again.

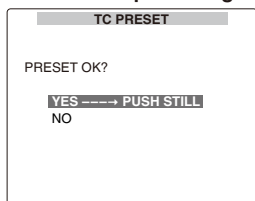

- 7** Press MENU twice to exit the menus.



With this unit, the time code value is adjusted in accordance with the format and frame rate. For this reason, bear in mind that making a change in the format or frame rate may result in discontinuity from the last time code value of the previous recording.

When SYSTEM FREQ is set to 50 Hz

Recording format	Frame rate	Time code adjustment
720P/25PN	—	Adjustable in 2-frame increments

When SYSTEM FREQ is set to 59.94 Hz

Recording format	Frame rate	Time code adjustment
1080i/24P, 1080i/24PA 480i/24P, 480i/24PA	—	Adjustable in 5-frame increments
720P/60P, 720P/30P 720P/24P	24	
720P/24PN	—	Adjustable in 4-frame increments
720P/30PN	—	Adjustable in 2-frame increments

Charging the built-in battery/Setting the time data (continued)

Setting user information

Setting user information allows you to store 8-digit memo (information such as the date and time) in the hexagonal format on the sub code track area. User information is automatically saved in the memory and retained after you turn off the power.

- 1 Set the **POWER** switch to **ON**.
- 2 In the setup menus, **RECORDING SETUP** screen **UB MODE**, select **USER**.
 - For menu operation (Page 95)
 - You can also use the menu buttons on the remote control. (Page 14)

Example: In the CAM mode

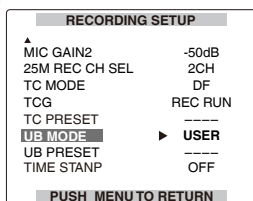

- 3 Push the Operation lever in the ▲ or ▼ direction to move to **UB PRESET** and press it again.

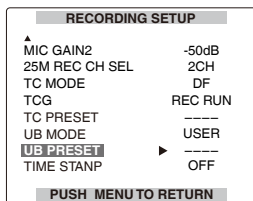

- 4 Push the Operation lever in the ▼ direction to move to **YES** and press it again.

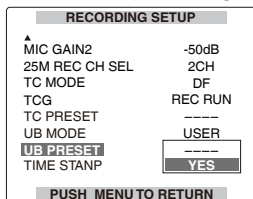

- 5 Set the user information. Push the Operation lever in the ▲ or ▼ direction to select user information characters.
 - You can use numbers from 0 to 9 and letters from A to F.

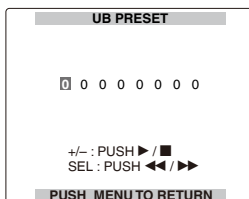

Push the Operation lever in the ▶ direction to move to the next digit, then push it in the ▲▼ direction to select a character.

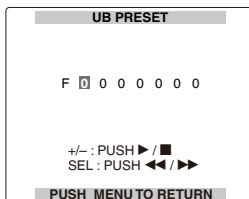

You can reset the user information to nothing by pressing **RESET** on the camera or the remote control.

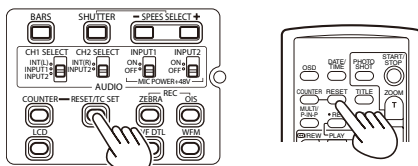

Camera or Remote control

- 6 Press the **MENU** button when you have finished setting the user information.



-
- 7** Push the Operation lever in the ▲ direction to move to YES and press it again.

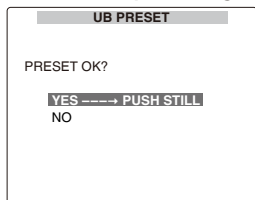

- 8** Press MENU twice to exit the menus.



Basic playback operations

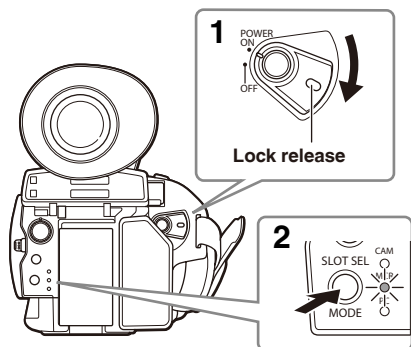

1 Turn the POWER switch to ON.

While pressing the lock release, turn the POWER switch to ON.

2 Press the mode button so the MCR lamp turns on.









The camera is now in the MCR mode.

- Each time you press the button, the mode changes as below.

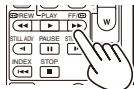
MCR ↔ CAM

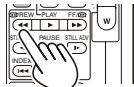
When you press the mode button while MCR is selected, the unit enters the PC (PC connection) mode. (Page 82)

For details on playing back clips using thumbnails, see Page 65.

Operations using the Operation lever	Remote Control
 <p>Play (▶) Use this button <u>in stop mode</u> to start playback from the beginning of the selected clip. <u>During playback</u>, the unit enters the variable speed search mode and starts 1x playback. (Page 75)</p>	
 <p>Fast-forward (▶▶) Use this button <u>during playback</u> to fast-forward the selected clip (4 x speed). When the thumbnail screen is cancelled, you can also perform this operation while the camera is stopped. When this button is held down, the playback speed becomes faster (32x speed). When pressed <u>during a pause</u>, playback advances one clip.</p>	
 <p>Rewind (◀◀) Use this button <u>during playback</u> to rewind the selected clip (4 x speed). When the thumbnail screen is cancelled, you can also perform this operation while the camera is stopped. When this button is held down, the playback speed becomes faster (32x speed). When pressed <u>during a pause</u>, playback goes back one clip.</p>	
 <p>Stop (■)</p>	
 <p>Pause () Press again to return to playback.</p>	

Thumbnail screen

Video data created on the P2 card in one shooting session is called a clip. When the MCR mode has been established, the clips will be displayed on the LCD screen as thumbnails. (When there is a large number of clips, it will take some time for them to be displayed on the screen.)

You can perform the following operations using the thumbnail screen.

- Play, repair and delete clips, add and delete shot marks, as well as add text memos.
- Format P2 cards and SD memory cards.
- Load the metadata (shooting information, etc.) from SD memory cards to the unit.

Basic thumbnail screen operations

To use the thumbnail menu:

1 On the thumbnail screen, press the MENU button to display the menu.

2 Push the Operation lever in the ▲ or ▼ direction and press it (or push it in the ► direction).

If another menu appears, repeat this step.

- To return to the previous screen, select EXIT and press the Operation lever or push it in the ◀ direction.
- To release the menu mode, press MENU.

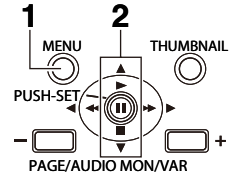

To select a clip: Push the Operation lever in the ◀ or ► direction to move the yellow frame to the clip you want to select, and press it again. (The frame changes to blue.) Pressing the Operation lever a second time deselects the thumbnail. To scroll the pages, press the PAGE (- or +) button.

To Play back clips: Select a thumbnail and push the Operation lever in the ► (playback) direction. (For details on playback, see Page 64.)

- Only clips recorded in the same format as the playback format (6 in the figure below) can be played back.

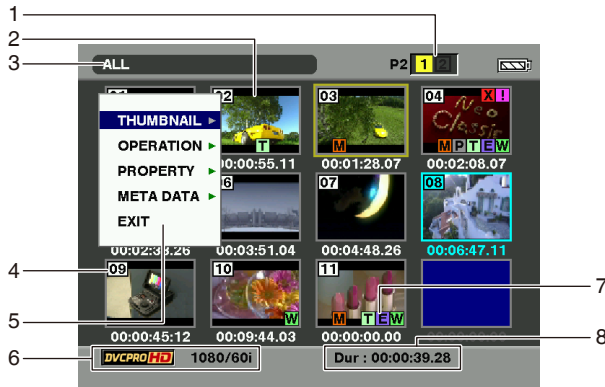

THUMBNAIL

- ALL CLIP
- SAME FORMAT CLIPS
- SELECTED CLIPS
- MARKED CLIPS
- TEXT MEMO CLIPS
- SLOT CLIPS
- SETUP
- EXIT

OPERATION

- DELETE
- FORMAT
- REPAIR CLIP
- RE-CONNECTION
- EXCH. THUMBNAIL
- EXIT

PROPERTY

- CLIP PROPERTY
- CARD STATUS
- DEVICES
- PROPERTY SETUP
- SYSTEM INFO
- EXIT

META DATA

- LOAD
- RECORD
- USER CLIP NAME
- INITIALIZE
- PROPERTY
- EXIT

- Thumbnail screens are output only from the VIDEO OUT terminal.

(Continued on the next page)

Thumbnail screen (continued)

1 Slot number display

The number of the slot with the P2 card containing the clip indicated by the yellow frame is shown here. (The number appears in yellow.) If a clip extends over the P2 cards in two slots, both numbers will appear in yellow.

- When one of the following warnings applies to an inserted P2 card, the frame around the slot number turns pink.

1) RUN DOWN CARD (Page 92)

2) DIR ENTRY NG CARD (Page 92)

2 Thumbnails

This is where the images representing the clips are displayed. (The initial images are displayed in the default setting.)

3 Thumbnail display status (Page 68)

The types of clips displayed as thumbnails appear in this area.

4 Clip numbers

The clips are displayed in the order in which they were shot. (up to 2000)

Clips in the wrong recording format or clips which cannot be played back for other reasons are shown in red.

To play back clips indicated in red, change the playback format while the thumbnail is displayed (Page 69), or change the MCR FORMAT and 576i (480i) MCR MODE on the setup menu RECORDING SETUP screen to the format described in 6 below. (Page 105)

- Clips on the playlist which have been edited and copied using the AJ-SPD850 memory card recorder or other such unit and which have more than one format (DV, DVCPRO or DVCPRO50) are shown in red, and these clips cannot be played back even when the MCR FORMAT item has been set.

5 Menu display

This is where the menu items are displayed. Select EXIT and press the Operation lever to close the menu and return to the original screen.

6 Recording mode/format display

This is where the recording mode and format of the recorded images are displayed.

7 Indicators

: Shot mark

This indicates that a clip has a shot mark.

: Wide

This indicates that a clip has been recorded in the 16:9 aspect ratio (wide screen). (576i (480i) recording)

: Incomplete clip

This indicator appears when the recording of a clip extends over two P2 cards and one of the cards is not found in the slot.

: Defective clip

This indicator appears for a clip whose recording was defective because the power was cut off during the recording process, for instance.

Clips indicated by the yellow defective clip indicator can be repaired.

Clips indicated by the red defective clip indicator cannot be repaired so delete them. If a clip cannot be deleted, first back up its data, and then format the P2 card. Clips in the wrong format are indicated by () instead.

: Text memo

This indicates that a clip has a text memo.

: Edit copy

This indicates that this is an edit copy clip. (You cannot perform editing with this camera.)

: Proxy

This indicates that a proxy has been added and recorded. (You cannot perform recording with this camera.)

8 Duration display

This displays the duration of the selected clip.

Adding shot marks to clips

Adding shot marks (M) will make it easier to find the clips you are looking for.

- 1 Push the Operation lever in the ◀ or ▶ direction to move the yellow frame to the clip to which you will add a shot mark.
- 2 Press the USER button to which the shot mark function has been allocated. (Page 43)

To release a shot mark, repeat the above steps.

- When the video data of a single shot is recorded in multiple P2 cards, you cannot set or release shot marks unless all the P2 cards that make up the video data are inserted into slots.

Clearing the thumbnail screen

Before performing setting menu operations (Page 95), you must clear the thumbnail screen. Release this in the same way when the camera-recorder is to be controlled from a nonlinear editor.

- 1 Press the THUMBNAIL button.



The normal playback standby screen (1394 input mode) appears.

Direct shooting functions

If you press the START/STOP button (red) in MCR mode, CAM mode will be automatically activated, and shooting will start.

Thumbnail operations

Selecting the thumbnail display method (THUMBNAIL)

You can display the kind of clips you want to see as thumbnails.

You can also set more precisely how you want the thumbnails to appear on the screen.

1 On the thumbnail screen, press the MENU button.

A menu now appears. (Page 65)

2 Push the Operation lever in the ▲ or ▼ direction to select THUMBNAIL and press it (or push it in the ► direction) again.

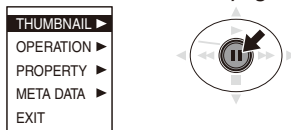

3 Push the Operation lever in the ▲ or ▼ direction to make a selection and press it again.

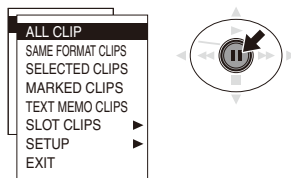

ALL CLIP:

All the clips are displayed.

SAME FORMAT CLIPS:

The clips in the format same as the MCR format are displayed.

SELECTED CLIPS:

The clips you have selected are displayed.

MARKED CLIPS:

The clips with shot marks are displayed.

TEXT MEMO CLIPS:

The clips with text memos are displayed. The thumbnails at text memo positions, time codes (TC), total number of memos and the current order of the clips are displayed.

To delete a text memo:

- 1) Move the yellow frame to the clip whose text memo is to be deleted, and press the Operation lever. A thumbnail of the text memo now appears.
- 2) Select the thumbnail of the text memo to be deleted.
- 3) Press the MENU button to display the menu, and select OPERATION-DELETE.

SLOT CLIPS:

The clips on the P2 card in the specified slot are displayed.

SETUP:

Various setup operations are performed.

EXIT:

Select this to return to the last screen.

Proceed to step 4 only when you have selected SETUP.

4 Push the Operation lever in the ▲ or ▼ direction to select an item and press it again.

ALL HIDE:

Selecting ON hides MARKED IND., TEXT MEMO IND., WIDE IND. and PROXY IND.

MARKED IND.:

Select this to set whether the shot mark indicator is to be displayed (ON/OFF).

TEXT MEMO IND.:

Select this to set whether the text memo indicator is to be displayed (ON/OFF).

WIDE IND.:

Select this to set whether the wide indicator is to be displayed (ON/OFF).

PROXY IND.:

Select this to set whether the proxy indicator is to be displayed (ON/OFF).

DATA DISPLAY:

Select the time code (TC), user information (UB), shooting time (TIME), shooting date (DATE), shooting date (DATE TIME) or user clip name (USER CLIP NAME) for the area where the clip time is displayed.

DATE FORMAT:

Select year/month/day (YMD), month/day/year (MDY) or day/month/year (DMY) as the order for displaying the recording date/time.

This format will be the same for the recording date displayed by the clip properties and the recording date displayed by DATA DISPLAY.

THUMBNAIL SIZE:

Select LARGE (3x2) or NORMAL (4x3) for full-screen displays of thumbnails.

PLAYBACK RESUME:

Resumes playback from the point where a previous playback operations was halted.

THUMBNAIL INIT:

Select this to return all the above settings to the factory (initialization) settings.

EXIT:

Select this to return to the last screen.

5 Press the MENU button to release the menu mode.

Changing playback format

Use the following steps to change the playback format in order to play back a clip in a playback format (a clip whose clip number is indicated in red) that differs from that currently selected.

1 Use the Operation lever in the thumbnail screen to move to the clip you want to play back.

2 Push the Operation lever in the ▼ direction and hold it down for 2 or more seconds.

- Thumbnail status indicates "UPDATING..." after which the previous screen reappears.
- When the recording format of a clip indicated by the yellow frame is a format playable by this unit, the playback format changes to enable playback of the clip with the yellow frame.

Deleting clips and formatting cards (OPERATION)

You can perform any of the following operations. If necessary, make preparations prior to undertaking the operations.



Deleting clips

- Select the clip to be deleted.

Formatting P2 cards or SD memory cards

- Insert the card to be formatted into the unit.
- When a card is formatted, all its data will be deleted.

Repairing bad clips

- Select the bad clip (indicated by ) you want to repair. (Note that clips indicated by a red  symbol cannot be repaired.)

Reconnecting incomplete clips

- Select an incomplete clip (indicated by ") you want to reconnect. Incomplete clips are usually grouped together.

Replacing thumbnails

- Attach text memos to clips and change them to TEXT MEMO CLIPS.
- Move the yellow frame to the thumbnail you want to edit.

1 On the thumbnail screen, press the MENU button.

A menu now appears. (Page 65)

2 Push the Operation lever in the ▲ or ▼ direction to select OPERATION and press it (or push it in the ► direction) again.



3 Push the Operation lever in the ▲ or ▼ direction to make a selection and press it again.

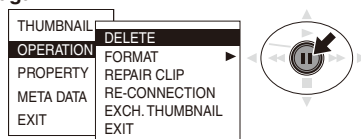

(Continued on the next page)

Thumbnail operations (continued)

DELETE:

Select this to delete the selected clip.

Select YES to delete the clip or NO to cancel the deletion, and press the Operation lever.

FORMAT:

Select this to format a P2 card or SD memory card.

When you move to FORMAT, the card selection screen will appear. Select the P2 slot (SLOT1 or SLOT2) or select SD CARD, and press the Operation lever. Select YES to format the card or NO to cancel the formatting, and press the Operation lever.

REPAIR CLIP:

Select this to repair defective clips.

Select YES to repair the clip or NO to cancel the repair, and press the Operation lever.

- The SHOT MARK and TEXT MEMO data are deleted when a clip is repaired.

RE-CONNECTION:

Use this function to reconnect clips that span multiple P2 cards.

Clips recorded across multiple P2 cards may become incomplete clips.

Should this happen, use the RE-CONNECTION function to merge the different clips to create one single clip.

Select YES/NO and push the Operation lever.

EXCH. THUMBNAIL:



Use this function to replace thumbnail images with images to which text memos have been attached.

Select YES/NO and push the Operation lever.

EXIT:

Select this to return to the last screen.

4 Press the MENU button to release the menu mode.

- When clips have been copied by operating Explorer, for instance, the “” indicator may appear on the clips. If this happens, “” can sometimes be released by downloading the latest version of the P2 viewer from the web site given below, installing it in your computer, and copying the clips again.

<https://eww.pavc.panasonic.co.jp/pro-av/>

Checking the clip or card information (PROPERTY)

You can perform any of the following operations. If necessary, make preparations prior to undertaking the operations.

Checking and repairing clip information

- Move the yellow frame to the clip to be checked.

Checking the P2 card information

- Insert the P2 card into the unit.

Checking the SD memory card information

- Insert the SD memory card into the unit.

Setting the P2 card memory capacity display

Checking the version of this system

1 On the thumbnail screen, press the MENU button.

A menu now appears. (Page 65)

2 Push the Operation lever in the ▲ or ▼ direction to select PROPERTY and press it (or push it in the ► direction) again.

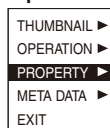

3 Push the Operation lever in the ▲ or ▼ direction to make a selection and press it again.

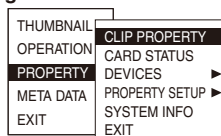

CLIP PROPERTY:

The information of the clip indicated by the yellow frame is displayed. (Page 71)

CARD STATUS:

The P2 card information is displayed. (Page 71)

DEVICES:

The SD memory card information is displayed. (Page 72)

PROPERTY SETUP:

Set the method of displaying the P2 card memory capacity. After selecting the P2 CARD CAP, select REMAIN (remaining memory) or USED (memory used), and press the Operation lever.

SYSTEM INFO:

The version of the system in this camera is displayed.

EXIT:

Select this to return to the last screen.

- Pressing the DISP/MODE CHK button in a thumbnail screen displays the CLIP PROPERTY screen. Press the button again to return to the thumbnail screen.

4 To exit the information screen, press the MENU button, push the Operation lever in the ► direction to select EXIT, and press it again.

Clip information screen

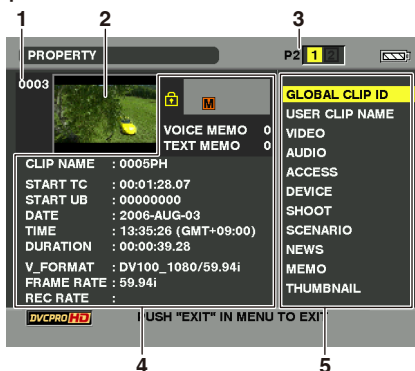
**1 Clip number****2 Thumbnail****3 Slot number****4 Clip information**

Various indicators that have been added to the clip and also various kinds of data are displayed. (🔒) appears if the P2 card is writeprotected)

CLIP NAME: Clip name

START TC: Time code value when recording started

START UB: User information value when recording started

DATE: Date when the recording was made

TIME: Time when recording started

DURATION: Clip length

V_FORMAT: Video signal format

FRAME RATE: Playback frame rate

REC RATE: Recording frame rate

- This display appears when recording using a setting for the FRAME RATE item on the SCENE FILE screen other than the default during 720P/25PN (720P/24PN or 720P/30PN) recording operations.

5 Clip metadata

The video and audio formats, videographer information and other detailed data are displayed here.

Select the desired item using the Operation lever, and press the Operation lever. (For details on the clip metadata, see Page 58.)

P2 card information screen

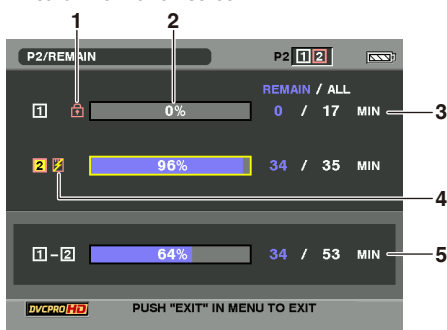
**1 Write protection mark****2 P2 card status**

The amount of memory remaining on the P2 card is displayed using a percentage bar. The following displays may appear, depending on the card status.

FORMAT ERROR: An unformatted P2 card has been inserted.

NOT SUPPORTED: A card not supported by the unit has been inserted.

NO CARD: A card has not been inserted.

- The information on the card in the slot indicated by the yellow frame (with yellow number) can be viewed by pressing the Operation lever.

BRAND: Name of manufacturer

MODEL NO.: Model number

SERIAL NO.: Serial number

USER ID: User ID

WARNING: Warning information

(Continued on the next page)

Thumbnail operations (continued)

- 3 P2 card remaining memory/total memory**
The P2 card's remaining memory and total memory are displayed here in 1-minute increments. Fractions of a minute are rounded off, meaning the display may not match the slot total.
- 4 Card warning mark**
This mark is displayed when one of the following warnings applies to a P2 card.
- 1) RUN DOWN CARD (Page 92)
 - 2) DIR ENTRY NG CARD (Page 92)
- The contents of the warning can be viewed by checking the card information as described above.
- 5 Slot total**
The figure represents the total remaining memory of the cards in the two slots. If a P2 card is write-protected, its remaining memory will not be included in the total remaining memory.
- When LOOP is set under REC FUNCTION, the slot total represents the standard recording time for loop recording. However, note that when PROPERTY SETUP: USED is selected in step 3 on the previous page, the used amount displayed by the slot total will be larger than the actual amount, and when PROPERTY SETUP: REMAIN is selected, the remaining amount displayed by the slot total will be smaller than the actual amount. (Page 48)

SD memory card information screen

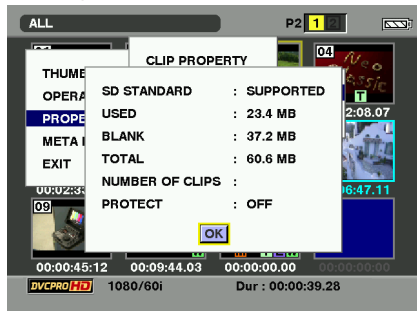

SD STANDARD: This indicates whether the SD memory card was formatted in compliance with the SD or SDHC standard. (SUPPORTED/NOT SUPPORTED).

USED: Space used

BLANK: Space available

TOTAL: Total space

NUMBER OF CLIPS: Number of clips

PROTECT: This indicates that the SD memory card is writeprotected.

Editing the recorded clip metadata

- 1 On the clip information screen, display the detailed clip metadata screen.**
- 2 Use the Operation lever to move the cursor to the item to be edited.**
Metadata that can be edited, such as "USER CLIP NAME", is displayed as shown in the following example.

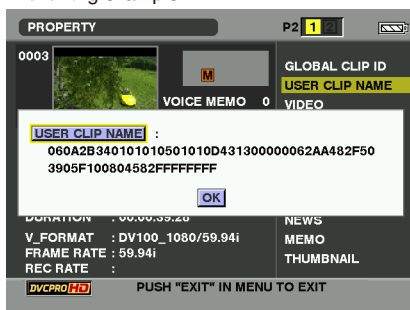

- 3 Press the Operation lever.**
The metadata editing screen (on-screen keyboard) is displayed. Enter characters using the on-screen keyboard to edit the metadata.

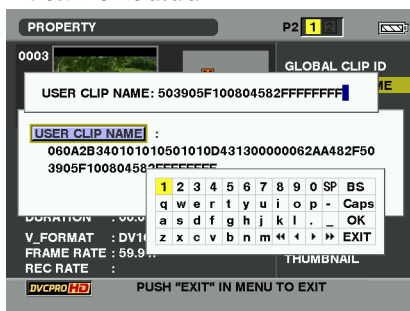

- 4 Press the "OK" button on the on-screen keyboard.**

The edited metadata is written to the clip, and the detailed clip metadata screen returns.

- When deleting items of LOCATION (shooting location) in SHOOT, items cannot be deleted independently. Make ALTITUDE blank, and the other items (LONGITUDE/LATITUDE) are also deleted.
- Metadata of a clip with the incomplete clip indicator cannot be edited. To edit metadata of a clip recorded in multiple P2 cards, insert all the P2 cards containing video data of the clip before starting editing.
- If MEMO contains 100 or more characters, it cannot be edited.

Uploading the metadata (META DATA)

You can perform any of the following operations. If necessary, make preparations prior to undertaking the operations.

Loading the metadata

- Insert the SD memory card on which the metadata is recorded into the unit. (For details on creating the metadata, see Page 58.)

Selecting whether to record the metadata on the P2 card

Changing recording method of USER CLIP NAME

Initializing the metadata inside the unit

Confirming and editing camera-recorder metadata

- 1 On the thumbnail screen, press the MENU button.**

A menu now appears. (Page 65)

- 2 Push the Operation lever in the ▲ or ▼ direction to select META DATA and press it (or push it in the ► direction) again.**

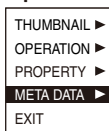

- 3 Push the Operation lever in the ▲ or ▼ direction to make a selection and press it again.**

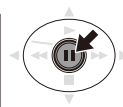
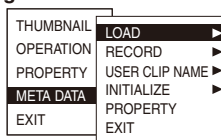

LOAD:

Select this to load the metadata recorded on the SD memory card into the unit.

When the Operation lever is pressed with operation moved to LOAD, the metadata on the SD memory card will be displayed. Therefore, press the Operation lever again. Select YES to load the metadata or NO to cancel the loading, and press the Operation lever.

- If characters other than single-byte alphanumeric characters are used in the metadata file name to be loaded, they are displayed as “*”.

RECORD:

Select this to set whether to record the metadata to be loaded into the unit simultaneously on a P2 card.

Select ON to record the metadata or OFF to cancel the recording, and press the Operation lever. The factory setting for this mode is OFF.

USER CLIP NAME:

The USER CLIP NAME recording method is selectable. Please refer to Appendix (Page 126).

INITIALIZE:

Select this to initialize the metadata which has been recorded in the unit.

Select YES to initialize the metadata or NO to cancel the initialization, and press the Operation lever. All the settings including the ON or OFF setting for RECORD are now cleared.

(Continued on the next page)

Thumbnail operations (continued)

PROPERTY:

Select this to display the metadata which has been recorded in the unit.

Push the Operation lever in the ▲ or ▼ direction, select PROPERTY and push the Operation lever to view the desired data. The Operation lever also allows you to change the data.

Changing method is the same as described in "Editing the recorded clip metadata".

(Page 72)

EXIT:

Select this to return to the last screen.

4 Press the MENU button to release the menu mode.

Useful playback functions

Variable speed search

This function enables you to change the playback speed and search for specific scenes.

- 1 Press the Operation lever in the ► (playback) direction during playback.

On the remote control, press the VAR. SEARCH button.

SEARCH button.

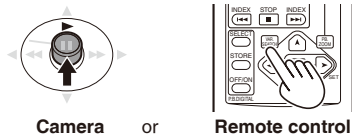

Camera

or

Remote control

[1x] appears on the screen and the media is played back at the normal speed.

- 2 Press the PAGE/AUDIO MON/VAR button to change the playback speed.

On the remote control, press the [▼] or [▲] button.

- The playback speed increases as follows each time you press the button; 1/5x, 1x, 2x, 4x, 12x, and 24x. Audio is not played at 12x or 24x speed.
- Press the "+" button to increase the speed and the "-" button to decrease the speed.

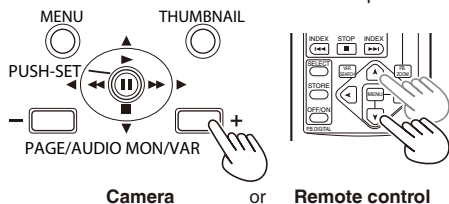

Camera

or

Remote control

To return to normal playback, push the Operation lever in the ► direction (playback) or press the VAR. SEARCH button on the remote control.

Slow playback

- 1 During play, press one of the STILL ADV (◀ or ▶) buttons on the remote control unit.

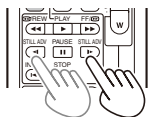

To return to normal playback, push the Operation lever in the ► (playback) direction.

Fast forward/rewind playback

- 1 During playback, push the Operation lever in the ◀◀ (rewind) or ▶▶ (fast-forward) direction.

This performs fast forward/rewind playback at 4x speed.

When this button is held down, the playback speed becomes faster (32x speed).

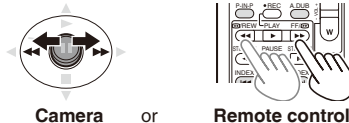

Camera

or

Remote control

To return to normal playback, push the Operation lever in the ► (playback) direction.

Frame-by-frame playback

- 1 Press II (pause) during playback to set the unit to the pause mode.

- 2 Press the PAGE/AUDIO MON/VAR button to play frame-by-frame.

On the remote control unit, press the STILL ADV (◀ or ▶) button.

- Press and hold the button to perform frame-by-frame play continuously.

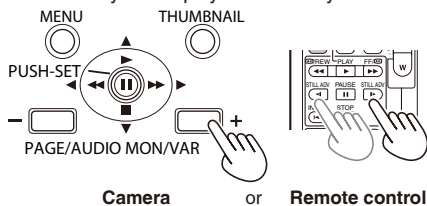

Camera

or

Remote control

To return to normal playback, push the Operation lever in the ► (playback) direction.

Useful playback functions (continued)

Clip skip

- 1 Press **II** (pause) during playback to set the unit to the pause mode.
- 2 Push the Operation lever in the **◀◀** (rewind) or **▶▶** (fast-forward) direction.

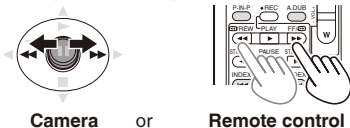

Camera or Remote control

Adjusting the volume

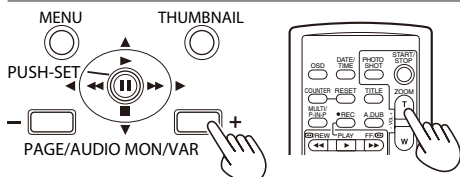

Camera or Remote control

- 1 With the **PAGE/AUDIO MON/VAR** button, adjust the volume of the sound that is output from the internal speaker and headphone jack.
On the remote control, press the **ZOOM/VOL** button.

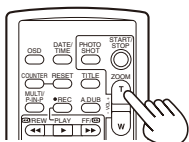

Viewing images on a monitor

You can view the images on a monitor if you connect the unit to a monitor using a BNC cable (not included), an AV cable (not included), or component video cable (included).

- 1 **Connect the camera-recorder to the TV set.** (Page 81)
- 2 **Start playback.**
 - To show the information that appears on the viewfinder and LCD, press the **OSD** button on the remote control. Press the **OSD** button again to clear the display.



Checking the date and time

Press the **DATE/TIME** button on the remote control to show the date and time of shooting on the screen. The display changes as follows each time you press the button.

Time
↓
Date
↓
Time and Date
↓
No display

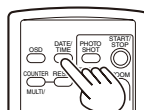

Connecting external units

Headphones

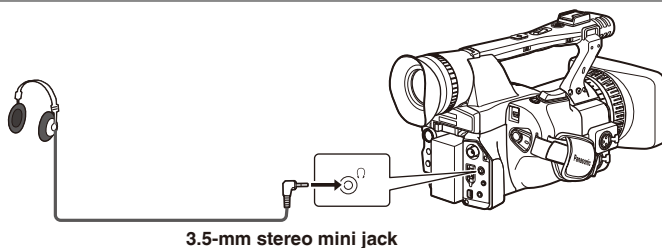

- Sound is no longer heard from the speaker when the headphones are connected.

External microphone

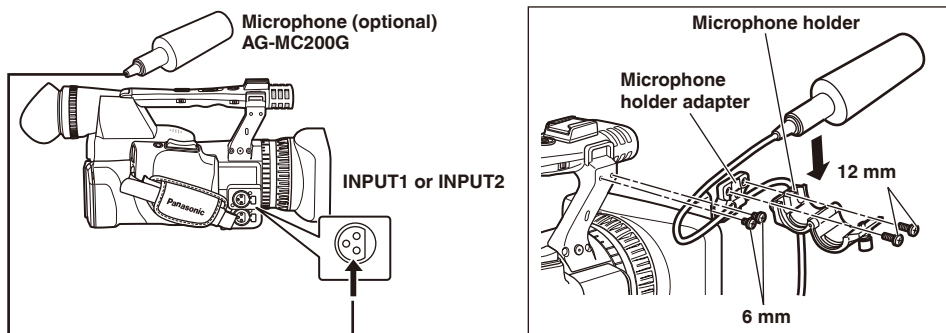

- When attaching an external microphone to the microphone shoe, use the supplied microphone holder and microphone holder adapter.
- When attaching the microphone holder and the microphone holder adapter, be sure to tighten the screws firmly even though you might hear a squeaking sound.

Connecting external units (continued)

Computer (non-linear editing/file transfer)

■ When connecting a 1394 cable

- Attach the provided two ferrite cores (length: 30 mm) to the both ends of the cable. After passing the cable as shown in the figure on the right, close the ferrite cores until they click into place and lock.

Always take sufficient care when handling the ferrite core, as it can be easily damaged when dropped or subjected to other impact.



Ferrite core (length: 30 mm)

■ When connecting a USB cable

- Attach the provided two ferrite cores (length: 35 mm) in such a way that the whole ferrite cores fit within about 5 cm from both ends of the cable. After threading the cable as shown in the figure on the right, close the ferrite cores until they click into place and lock.

Always take sufficient care when handling the ferrite core, as it can be easily damaged when dropped or subjected to other impact.

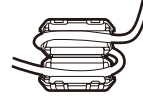

Ferrite core (length: 35 mm)

File transfer/nonlinear editing

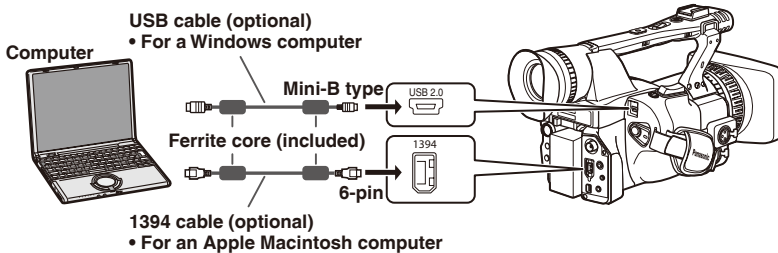

- When connecting a USB cable, first connect the cable to the PC.
- When connecting to a device having 4-pin type 1394 connector, first connect the cable to the 6-pin type 1394 connector on the camera.
- For details on the computer's conditions and other factors, see Page 82.

1394 AVC transfer/nonlinear editing

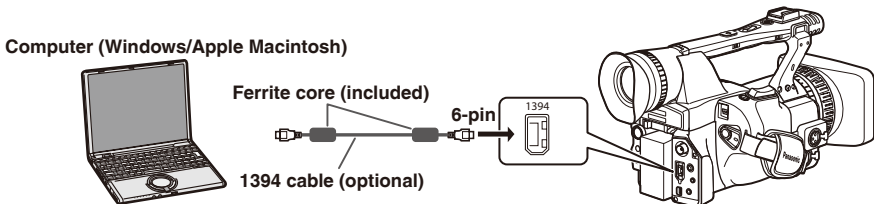

- When controlling this camera from a non-linear editor, cancel the thumbnail screen on the camera. (Page 67)
- No guarantees are given for images and audio signals which are output simultaneously from the camerarecorder while data is being transferred from a computer to the camera-recorder.
- The model name will appear on the computer screen.
- When connecting to a device having 4-pin type 1394 connector, first connect the cable to the 6-pin type 1394 connector on the camera.

When connecting the unit to an Apple Macintosh computer

- Connect the 1394 cable after turning on the power of the Apple Macintosh computer. Otherwise, the unit may not be mounted.
- The unit may not be recognized after the Apple Macintosh computer has been placed in the hibernation state by its power-saving setting. In this case, disconnect the 1394 cable and then re-connect it.

If the unit is not mounted properly on an Apple Macintosh computer

- When the P2 card access lamp flashes orange
 1. Select [Applications] → [Utilities] → and start up [Disc Utility].
 2. Select a grayed-out volume among volumes of the X.X GB Panasonic disc, and click "Mount."
- When the P2 card access lamp is off
Eject the P2 card, and insert it again. If the unit is still not mounted, disconnect the 1394 cable and then re-connect it.

Hard disk drive (data copying)

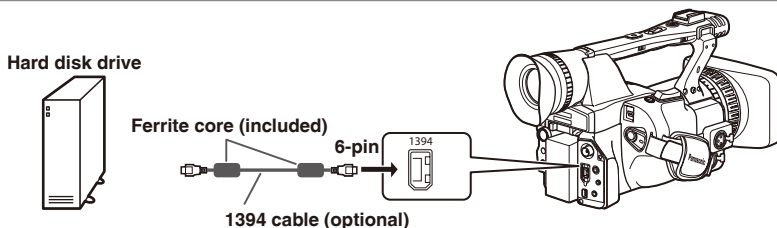

- Before proceeding to connect or disconnect 1394 cable, be absolutely sure to turn off the power of the units.
- Before proceeding to connect the unit which uses a 6-pin type 1394 connector, carefully check the shape of the 1394 cable and the connectors on the 1394 cable. Connecting a connector upside down may damage the parts inside the unit and cause malfunctioning. The above also applies to USB cable as well.
- When connecting to a device having 4-pin type 1394 connector, first connect the cable to the 6-pin type 1394 connector on the camera.
- Do not apply force when connecting 1394 cable to 1394 connector as this may damage the connector.

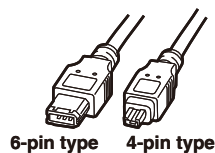

Connecting external units (continued)

Digital video equipment (Dubbing)

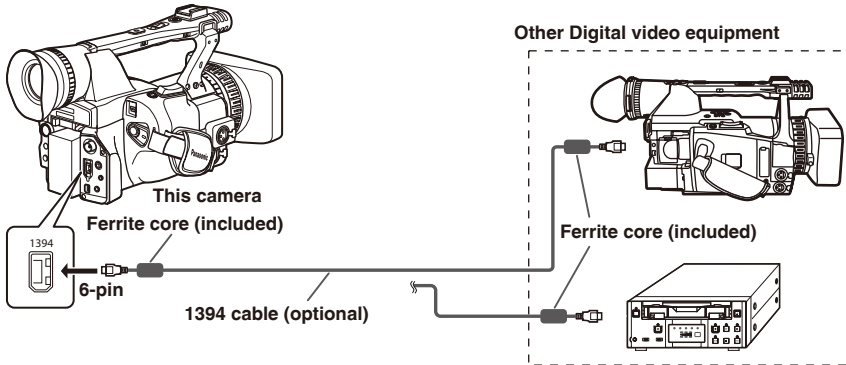

■ You can connect a digital video unit equipped with a 1394 connector and digitally transfer video and audio signals as well as time code.

- Before proceeding to connect or disconnect 1394 cable, be absolutely sure to turn off the power of the units.
- Before proceeding to connect the unit which uses a 6-pin type 1394 connector, carefully check the shape of the 1394 cable and the connectors on the 1394 cable. Connecting a connector upside down may damage the parts inside the unit and cause malfunctioning.
- When connecting the camera to a device with a 4-pin type 1394 connector, first connect the 6-pin type connector of the cable to the camera.
- When recording signals from an external unit, first check that video signals are supplied.
- While signals from an external unit are being recorded, do not stop output on the external unit side or disconnect any of cables. This may lead to a failure to recognize the signals when you do recording again.
- While signals from an external unit are being recorded, do not change the format of the signals being output from the external unit. Doing so may make it impossible to record correctly.
- Do not apply force when connecting 1394 cable to 1394 connector as this may damage the connector.
- When signals are input from an external unit via the 1394 cable, video is output from the terminals such as the SDI OUT terminal, but the output video is only for check purpose and the quality is not guaranteed. (Frame skip and overlap occur.)
- The automatic recording function in the DVD unit may not function properly. In a case like this, proceed with the recording manually.

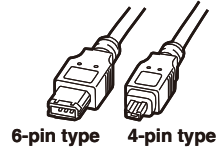

Video deck (Dubbing)

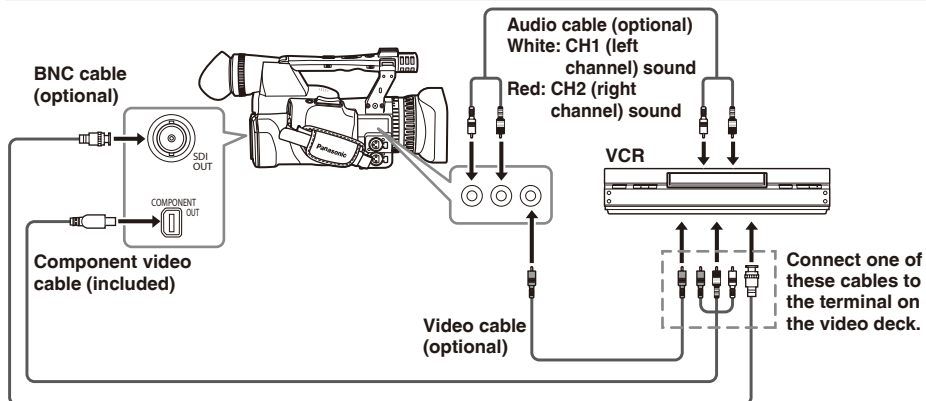

AUTO REC function

When recording is started or stopped on this camera, recording start/stop information can be output through the SDI (HD) connector to control external device.

* The external device should support this function.

TV/Monitor (playback/dubbing)

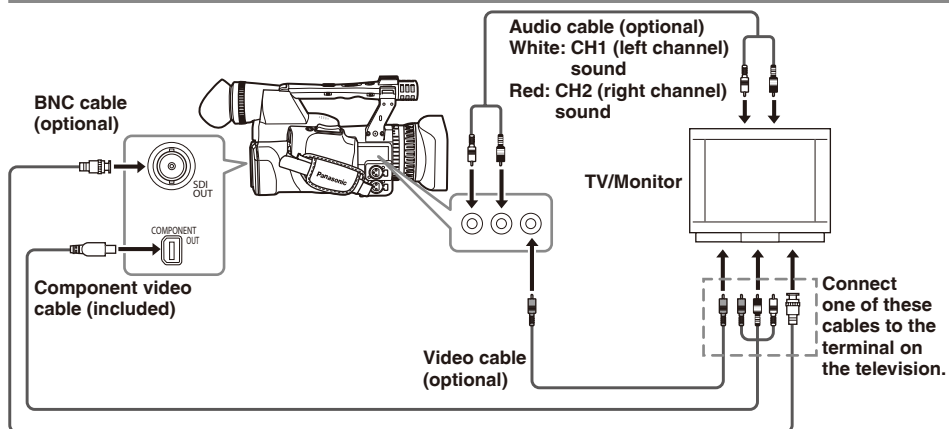

Nonlinear editing with P2 card (PC mode)

You can edit the video data on P2 cards nonlinearly by connecting the unit to a computer used for editing by means of a USB cable (Windows) or 1394 cable (Apple Macintosh).*1 (Connections : Page 78)

*1 When the unit is connected to a computer with a 1394 cable, you can only read data from P2 cards but you cannot write data to P2 cards.

The following conditions must be met if the USB cable is to be used to make the connection.

- Your computer must run Windows 2000, Windows XP or Windows Vista.
- USB dedicated driver (provided on the CD-ROM supplied) must be installed in your computer.
- Your computer must support USB2.0 (High Speed, Mass Storage Class). (USB 1.1 is not supported.)
- Only one computer can be connected.
- When the unit is connected via USB cable, the series name of the unit should appear on the computer screen.
- No operations can be performed if a hub or other unit is connected between the unit and your computer.
- Do not use a USB cable longer than 3 meters. Otherwise, malfunctions may occur.
- Operation is not guaranteed in Macintosh operating systems.

The following conditions must be met if the 1394 cable is to be used to make the connection.

- Your computer must run Apple MacOSX 10.3 or later.
 - Your computer must support 1394.a (SBP2 protocol).
 - Operation is not guaranteed in Windows operating systems.
-
- Insert the P2 card into the unit. (Page 25)

1 Set the unit's POWER switch to ON.

2 Select PC MODE on the setting menu OTHER FUNCTIONS screen and press the Operation lever (or push it in the ► direction).

- For menu operations (Page 95)
- You can also use the menu buttons on the remote control. (Page 14)

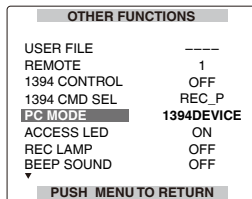

3 Push the Operation lever in the ▲ or ▼ direction to select a USB DEVICE or 1394 DEVICE and press it again.

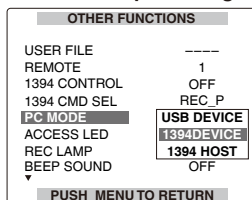

4 Press the MENU button twice to release menu mode.



5 Press the mode button to light up the MCR lamp and then hold the button down (for 2 or more seconds).

The PC lamp now lights, and PC mode is established.

When the P2 card is in an accessible status, USB (or 1394) DEVICE CONNECT is displayed on the camera.

(If DISCONNECT is displayed, you cannot operate the camera.)

6 Proceed with nonlinear editing using your computer.

An icon for the P2 card contents appears as a removable disk in My Computer of your computer.

- For further details, refer to the instructions for your computer's editing software.
- When replacing one card with another, if the USB connection is used, check that the access lamp is not flashing and that the data on the card is not being accessed before ejecting the card. If the 1394 connection is used, place the drive icon into the computer's recycle bin before ejecting the card.
- The unit cannot be operated while in PC mode.
- When the cable is to be disconnected, proceed with "Safely Remove Hardware" on the computer.

In the case of a 1394 connection, first confirm that "1394 DEVICE DISCONNECT" is displayed on the camera-recorder before disconnecting the cable. In the case of a USB connection, "USB DEVICE CONNECT" will remain displayed so check that the card is not being accessed before disconnecting the cable.

7 Switch OFF the camera.

- When turning the power off, proceed with "Safely Remove Hardware" on the computer. In the case of a 1394 connection, first confirm that "1394 DEVICE DISCONNECT" is displayed on the camera-recorder before turning the power off. In the case of a USB connection, "USB DEVICE CONNECT" will remain displayed so check that the card is not being accessed before turning the power off.
- You cannot cancel the PC mode even if you press the mode button for more than 2 seconds.

P2 cards are compliant with the Type-II standard so you can insert them straight into the computer's card slots and proceed with nonlinear editing.

- The Card Bus driver is contained in the CD-ROM provided.
-

Copying from P2 cards to the hard disk drive (1394 HOST mode)

- Use an HDD (hard disk drive) that has sufficient capacity to permit copying.
- Before copying the data, format the hard disk drive so that it can be used by the unit. Bear in mind that this process will delete all the data on the drive.
- Connect the camera to an HDD using the 1394 cable. (Page 79)
- Do not connect the camera to two or more HDD (chain, hub, etc.), even if they are not turned ON.
- Insert the P2 card into the unit. (Page 25)

1 First turn on the power of the HDD (1394. a SBP2 supported) to be connected, and connect it using the 1394 cable. Then turn the unit's POWER switch to ON.

2 Select 1394 HOST for PC MODE on the setting menu OTHER FUNCTIONS screen, and press the Operation lever.

- For menu operations (Page 95)

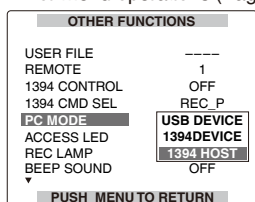

3 Press the MENU button twice to release the menu mode.



4 Press the mode button to light up the MCR lamp, and then hold the button down for 2 or more seconds.

The PC lamp now lights, and PC mode is established.

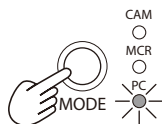

5 Only when the hard disk drive is not formatted:

Push the Operation lever in the ▲ or ▼ direction to select FORMAT (HDD) and press it again.

Then push the Operation lever in the ▲ or ▼ direction to select YES and press it again. Formatting now starts. (Formatting is completed in about 2 to 3 seconds.)



6 When formatting is complete: Push the Operation lever in the ▲ or ▼ direction to select COPY TO HDD and press it again.

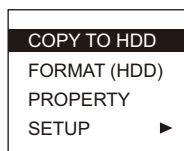

- Data is copied onto the HDD on a card by card basis.

7 Push the Operation lever in the ▲ or ▼ direction to select a card slot and press it again.

Then push the Operation lever in the ▲ or ▼ direction to select YES and press it again. Copying now starts.

- You can carry out copying up to 15 times to one HDD.

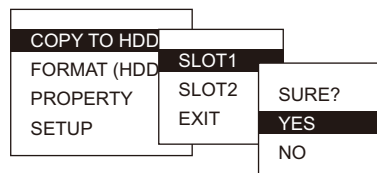

8 When copying is complete: Switch OFF the camera.

- You cannot cancel the 1394 HOST mode even if you press the operation mode button for more than 2 seconds.

To check the HDD status

The color of  indicates the HDD status, as below.

White: HDD is connected and can be used.

Black: HDD is not connected.

Red: Copy cannot be made to the HDD since it is incorrectly formatted, etc.

- When the color is red, correctly format the HDD at step 5 before copying data onto it.

To check the data copied into the hard disk drive

After completing step 4 on the previous page, push the Operation lever in the ▲ or ▼ direction to select PROPERTY and press it again.

The contents of the hard disk drive are displayed.

- To view detailed hard disk data, push the Operation lever in the ▲ or ▼ direction to select an item and press it again.

To verify the data when copying it into the hard disk drive

After completing step 4 on the previous page, push the Operation lever in the ▲ or ▼ direction to select YES for the VERIFY option under SETUP.

- Copying to the P2 card is completed, even if you interrupt processing during verification.

- You cannot copy data from the hard disk drive to a P2 card.
- Use a hard disk drive under the following conditions.
 - Power is supplied from a source other than the 1394 bus. (It is not supplied from the unit.)
 - You may format the hard disk drive for usage by the unit.
 - Use the hard disk drive within the guaranteed operating range (humidity and other environmental conditions).
 - Do not place the hard disk drive in an unstable locations or locations subjected to vibrations.
- Some HDD may not operate correctly.
- During formatting or copying, do not remove any cables, eject the P2 card, or turn off the power for the unit or hard disk drive. The power will need to be turned on again.
- No guarantees are made for operation if the 1394 HOST mode is established without first connecting the HDD (1394.a SBP2 supported) and then the HDD is connected. In this case, turn off the power, and then release the 1394 HOST mode.
- **The hard disk drive is an extremely highprecision device. Therefore, it is highly possible that data cannot be read in certain operating environments.**
- **Please note that our company will not be liable for any data losses due to hard disk drive failure or other faults, or any other direct or indirect damage related to these problems.**
- **If you rewrite the contents of the HDD used to carry out copying from the camera to another PC, the subsequent operation in the camera and the data in the HDD cannot be guaranteed.**

- It is recommended that you first restore any defective clips contained in the P2 card before copying the data.
- In order to avoid the occurrence of trouble in copying, formatting or other operations, it is recommended that you perform these operations after ensuring that power supply has stabilized.

Warnings

HDD CAPACITY FULL!

There is not enough free memory on the HDD.

TOO MANY PARTITIONS!

There are too many partitions.*1

HDD DISCONNECTED!

The HDD has been disconnected.

CANNOT FORMAT!

Initializing cannot be performed.

TOO MANY TARGETS!

There are too many 1394 connection destinations.

CANNOT ACCESS TARGET!

The connection destination cannot be accessed.

CANNOT ACCESS CARD!

The card cannot be accessed.

MISMATCH COMPONENT!

There is a mismatch with the connection destination.

UNKNOWN DEVICE CONNECTED!

A device other than an HDD has been connected.

P2 CARD IS UNFORMATTED!

The P2 card is still unformatted.

CARD IS EMPTY! CANNOT COPY!

There is no data on the P2 card and so it cannot be copied.

VERIFICATION FAILED!

A mismatch was discovered by verification.

TURN POWER OFF!

Turn off the power.

CANNOT RECOGNIZE HDD!

HDD recognition failed.

*1 Data can be copied to up to fifteen P2 cards.

Dubbing

Digital input/output

You can perform dubbing with a high image quality by means of digital signals by using a 1394 cable to connect this unit to a digital video unit equipped with a 1394 connector.

1 Connect the digital video equipment to this unit. (Page 80)

2 Press the unit's mode button to switch to the MCR mode.

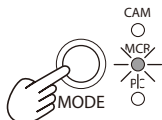

- Cancel the thumbnail screen when in MCR mode.
- Set up the connected equipment for playback or recording.
- When performing digital dubbing with a second camera-recorder or other device, a recording cannot be made unless the signal formats at the output side and input side are identical.
- When using with the 720P/25PN (720P/24PN and 720P/30PN) settings, digital output in MCR mode only is performed. Digital input is not possible.

3 Start playing back in the player.

4 Start recording in the recorder.

- If you are using this unit as the recorder, press the two REC buttons (ZEBRA and OIS) at the same time. On the remote control unit, press the PLAY button while holding down the REC button.

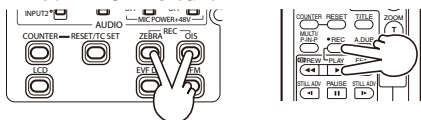

Camera or Remote control

5 Stop recording in the recorder.

- If the unit is used as the recorder, push the Operation lever to the ■ (stop) direction.

6 Stop playback on the other unit.

- If the unit is used as the player, push the Operation lever to the ■ (stop) direction.

- The DV format is converted into 48K/2CH or 4CH. In the case of 1080i and 720P, channels 1 to 4 are recorded directly, and channels 5 to 8 are not recorded.
- If you have set 1394 TC REGEN or 1394 UB REGEN to on in the recording unit's menus you can copy the time code and user information from the playback source. (Page 106)

Do not start recording until you can see the images on the recording unit's screen. Time code and user information may not be correctly recorded if you start recording before the images are received.

Analog output

You can record images you have shot on this unit to an S-VHS (VHS) tape in a video deck.

1 Connect the video recording device to the unit. (Page 81)

2 Press the mode button to switch to the MCR mode.

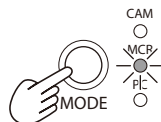

3 Set the unit to playback.

4 Start the recording by operating the video recording device.

When video recording is completed, stop the video recording device.

To stop playback, push the Operation lever to the ■ (stop) direction.

Screen displays

Regular displays

For details on the safety zone, refer to 38.

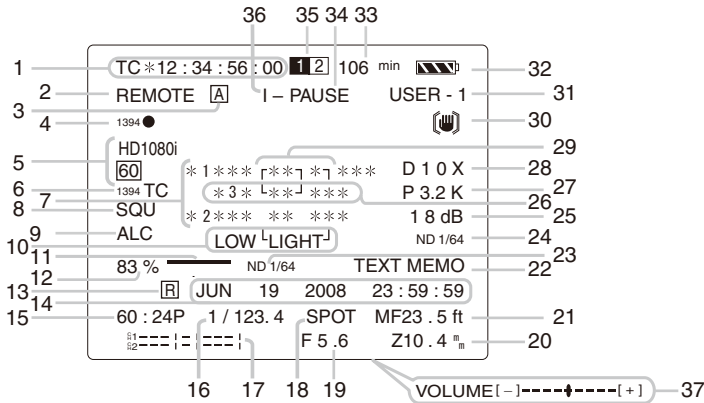

1 Time code displays

Each time you press the COUNTER button, the display switches over to the following data (or no indication).

COUNTER: (CAM mode only)

Counter value

CLIP COUNTER: (CAM mode only)

Counter value in memory stop mode

The CLIP COUNTER appears when CLIP is selected under REC COUNTER in the setup menu DISPLAY SETUP screen.

TC:

Time code value. When the time code value could not be read correctly from the P2 card, [TC*] is displayed.

When it acts in drop frame mode, the colon between seconds and frames become “.”.

tc: (Only in 59.94 Hz FILM CAM mode)

Time code value. (During FILM CAM mode, the frame digits are displayed in 24 frames) When the time code value could not be read correctly from the P2 card, [tc*] is displayed.

When it acts in drop frame mode, the colon between seconds and frames become “.”.

UB:

User information

When user information could not be read correctly from the P2 card, [UB*] is displayed.

FR:

Frame rate information for recording

FR 50i: 50i interlace mode (50 fields/sec.)

FR 50P: 50P progressive mode (50 frames/sec.)

FR 25P: 25P progressive mode (25 frames/sec.)

FR 60i: 60i interlace mode (60 fields/sec.)

FR 60P: 60P progressive mode (60 frames/sec.)

FR 30P: 30P progressive mode (30 frames/sec.)

FR 24P: 24P progressive mode (24 frames/sec.)

FR 24PA: 24P advanced mode (24 frames/sec.)

When in FR24P and FR 24PA mode, the sequence information of the frame conversion at the final place.

2 Warnings

REMOTE:

Blinks when the wrong equipment setting is selected on the remote control unit.



Blinks when a P2 card has not been inserted, or when the camera is in a write-protected state.



FULL:

Blinks when there is no remaining capacity in the P2 card.



LACK:

Blinks in the loop rec mode when the remaining capacity of the P2 card is insufficient.



Lights when the internal battery for the calendar has run out. (Page 60)

3 AUTO/MANUAL switch operation display

This display appears if a function which has been set on the setting menu AUTO SW screen is operating when the AUTO/MANUAL switch has been pressed.

4 Backup unit displays

The status of the backup unit connected to the 1394 connector is displayed here.

Nothing is displayed if in the setup menus, OTHER FUNCTIONS screen, 1394 CONTROL, you have selected "OFF".

1394 ●: Recording

1394 III: Recording standby

1394 [X]: The backup unit cannot be controlled.

1394 -: The backup unit is not connected.

1394- -: The backup unit is connected but is in a mode other than recording or recording standby.

5 Recording format and system frequency (P2 card) (Page 105) display

6 1394TC display

Appears when the 1394 IN PRESET option on the setting menu RECORDING SETUP screen is ON. (This appears in the MCR mode.)

7 Information display

Following information is displayed depending on the situation.

- Performance of the auto white balance or the auto black balance
- Warning (Page 92)
- The functions allocated to the USER buttons are displayed while you hold down the DISP/MODE CHK button.

8 Squeeze information

Appears when in the setup menus, CAMERA SETUP screen, ASPECT CONV, you have selected "SQUEEZE" (Page 101) or when playing back images recorded in the squeeze mode.

9 Mic level auto control

Appears when in the setup menus, RECORDING SETUP screen, MIC ALC, you have selected "ON".

10 AWB error

LOWLIGHT: Appears when the brightness level adjusted by the auto white balance is too low.

C TEMP**: Appears when the WHITE BAL switch position is changed, the power is turned on, and COLOR TEMP Ach/COLOR TEMP Bch are set to a value other than 0 on the setting menu SCENE FILE screen while in the auto white balance adjustment.

11 Focus bar

The focus bar appears when FOCUS BAR is set to ON in the setup menu DISPLAY SETUP screen.

The focus bar extends to the right when the image is in focus.

12 Marker luminance display

When markers are displayed, the brightness level around the center of the screen is indicated as 0% to 99%. "99%†" appears if the percentage is over 99.

13 Time stamp recording display

The time stamp recording appears when TIME STAMP is set to ON on the setting menu RECORDING SETUP screen.

14 Calendar

Month:

JAN (January), FEB (February), MAR (March), APR (April), MAY (May), JUN (June), JUL (July), AUG (August), SEP (September), OCT (October), NOV (November), DEC (December)

Day of the month

Year: 2000 - 2030

Hours

Minutes

Seconds

mmm dd yyyy hh:mm:ss

15 Recording/playback frame rate display

Apart from the case of 720/25PN (720/30PN and 720/24PN), only the recording frame rate is displayed.

16 Shutter speed

The shutter speed is displayed here.

17 Audio level meter (Page 53)

18 Auto iris control displays

STD: Standard auto-iris control

SPOT: Auto iris control for spotlight

BACK: Auto iris control for backlight compensation

Screen displays (continued)

19 IRIS display

In CAM mode, displays the F value during shooting.

Only in the 576i (480i) DV format, the F value during shooting is also displayed during playback when ON was selected under CAMERA DATA of the setting menu DISPLAY SETUP screen.

20 Zoom position display

The zoom position is displayed with Z00 (maximum wide-angle) - Z99 (maximum zoom).

The unit can be switched to mm in the ZOOM•FOCUS option of the setting menu DISPLAY SETUP screen.

21 Focus control display

Displays the focus control information with 99-00.

In the auto focus mode, AF appears. In the manual focus mode, MF appears, and when MF ASSIST is set to ON on the setting menu SW MODE screen, MA appears. When the display is set to macro control, the black and white of AF or MF are displayed in reverse.

95 (Distance to the subject: infinity)

:

00 (Distance to the subject: approx. 5 cm)

Depending on the zoom position, the macro range may not be enabled. Also, depending on the zoom position, the lower limit value of macro range may be different.

The units can be switched between feet and m in the ZOOM•FOCUS option of the setting menu DISPLAY SETUP screen.

22 TEXT MEMO and SHOT MARK display

This display lights when the USER button to which the TEXT MEMO function has already been allocated is pressed while recording or playback and the text memo is recorded.

- MARK ON appears when the USER button to which the SHOT MARK function has already been allocated is pressed while recording and a shot mark is added to the clip being recorded. Pressing the USER button again deletes the shot mark, and MARK OFF appears.
- INVALID appears when text memo could not be recorded, or when a shot mark could not be added or deleted.

23 Recommended ND filter

The recommended ND filter under the current shooting conditions is displayed here.

24 ND filter display

ND filter selected is displayed.

25 Gain display

In CAM mode, displays the gain value of the image amplifier configured. (During the auto mode, AGC is displayed.)

Only in the 576i (480i) DV format, the gain value during shooting is also displayed during playback when ON was selected under CAMERA DATA of the setting menu DISPLAY SETUP screen.

26 AWB operation display

The white balance operation is indicated here.

27 AWB information display

Displays the information of white balance.

ATW: When ATW is set

P3.2K/P5.6K: In the case of preset

Ach/Bch: In the case of A/B

LOCK: When ATW is locked

28 Digital zoom display

Shows the digital zoom ratio.

D 2X: 2x

D 5X: 5x

D 10X: 10x

29 Displays marker

During shooting, pressing the ZEBRA button once or twice will display the marker.

30 Optical Image Stabilizer (OIS) display

In CAM mode, (OIS) appears when images were shot in the optical image stabilization mode.

Only in the 576i (480i) DV format, (OIS) also appears in playback mode when ON was selected under CAMERA DATA of the setting menu DISPLAY SETUP screen and images were shot in the optical image stabilization mode.

31 Scene file name display (in CAM mode) (Page 54)

32 Remaining battery charge

As the remaining battery charge drops, the display changes as follows: 



When the battery has completely discharged,



 () blinks.

(When the AC adapter is being used, a display other than  may appear: this is not a sign of malfunctioning.)

33 Media remaining memory display

Displays the remaining time.

- In P2 CARD REMAIN on the setting menu DISPLAY SETUP screen, select TOTAL to display total remaining time for all inserted cards or ONE-CARD (highlighted) to display the time remaining only on the card selected for recording. During MODE CHECK, it is possible to confirm the remaining time for the setting not selected in the menu.
- No indication is made while the remaining time is being calculated.
- An ongoing loop recording is indicated as "LOOP" and in MODE CHECK, the standard recording time appears after loop recording ends.
- The remaining time indication starts to flash when a total of less than 2 minutes remains.
- The remaining time is indicated in 1 minute increments between 0 to 999 minutes.

34 Operational state display

REC: Recording

PAUSE: Recording pause

⏏: Play pause

▶: Play

⏏▶ (<<▶): Fast-forward/Fast-forward play
(Rewind/Fast-backward play)

⏏▶ (<▶): Slow play (Reverse slow play)

CHK: Rec check

⏏▶ (<<▶): Cue (reverse cue)

⏏▶▶ (<▶▶): Frame-by-frame (Reverse Frame-by-frame)

x▶/x▶▶ (x</x<<): Variable-speed search
(Reverse variable-speed search)

35 Media information display

The card slot where the P2 card was inserted and the basic information of the media are displayed here.

1 2 **lights:** P2 card on which data can be recorded.

1 2 **lights green:** P2 card on which data is to be recorded.

1 2 **flashes:** Card recognition underway.

□ □: No card inserted.

P: Write-protected

F: Full memory

X: Cannot recognize

E: Card with format error (becomes normal if formatted)

36 Special recording display

This display appears when the REC FUNCTION option of the setting menu RECORDING SETUP screen is set to INTERVAL, ONE SHOT or LOOP, and when PRE REC is set to ON.

37 Monitor sound volume level meter

When you press the PAGE/AUDIO MON/ VAR button, the sound volume output from the builtin speaker and headphone jack is displayed.

38 Safety zone

The range of the zone is indicated by the SAFETY ZONE item (Page 109) on the DISPLAY SETUP screen.

4:3: This indicates the position which is cropped to 4:3.



13:9: This indicates the position which is cropped to 13:9.



14:9: This indicates the position which is cropped to 14:9.



90%: This indicates the range (90%) in which signals can be displayed by an ordinary homeuse TV set.



Screen displays (continued)

Warnings

COPY INHIBITED

Can not record correctly because of the input signal copy-guarded.

EXTERNAL 1394 DISCONNECT

When the 1394 CONTROL item of the OTHER FUNCTIONS screen of the Setup menu is set to EXT and recording without connecting external units with 1394 terminal, this display appears.

INCOMPATIBLE CARD

The card cannot be used since it does not comply with the specified standard.

RUN DOWN CARD

The maximum number of overwrites on the P2 card has been exceeded.
Operation continues. However, recording or playback may not operate correctly. It is recommended that you replace the P2 card with another one.

DIR ENTRY NG CARD

The directory structure on the P2 card is not supported.
Operation continues. However, recording or playback may not operate correctly.
The P2 card cannot be used for the special recording functions (interval recording, one-shot recording, and loop recording).
Back up data on the P2 card as soon as possible, and format the card before using it again.

FORMAT ERR !

This card is not compliant with the P2 standard.

LOW BATTERY

No operations can be performed since the battery charge is low.

<Thumbnail operations>

CANNOT ACCESS

Cannot access clips.

CANNOT DELETE

Cannot delete clips.

CANNOT FORMAT

Cannot format P2 cards or SD memory cards.

CANNOT REPAIR

Cannot repair clips.

CARD FULL

The P2 card does not have enough free space for recording.

WRITE PROTECTED

The P2 card or SD memory card is writeprotected.

NO CARD

A P2 card or SD memory card has not been inserted.

NO FILE

There are no files (version upgrade files, etc.).

Errors

These are displayed when an error occurs in the unit, P2 card, or other component. If the problem is not fixed by turning the power off and then on again, either replace the card based on the error information, or consult with your dealer as to which one is to be purchased.

CANNOT PLAY

This is displayed when trouble has occurred during playback.

CARD ERR (1) (2) (1/2)

(Trouble has occurred in the P2 card found in the slot indicated by the number.)

CLIP ERROR (clip trouble)

UPDATING (clip recording)

ERROR (other type of trouble)

SYSTEM ERROR

This is displayed when trouble has occurred in the system. Switch ON the power again.

P2 MICON ERROR (no P2 microcomputer response)

P2 CONTROL ERROR (trouble in P2 control)

REC RAM OVERFLOW (recording RAM overflow)

TURN POWER OFF

This display appears when an abnormality occurs as a result of the card being pulled out while data is being accessed.

REC WARNING

This is displayed when trouble has occurred during recording. Carry out recording once again. If the warning persists, consult your dealer.

CARD ERR (1) (2) (1/2)

(Trouble has occurred in the P2 card found in the slot indicated by the number.)

- If the warning continues, turn off the power.
- If the warning appears even when recording is carried out again, replace the card with another one.

ERROR (other type of trouble)

WARNING

When trouble occurs with camera systems,
WARNING is displayed.

FOCUS LOCK (Abnormal focus operation)

PSD NG (Abnormal vibration detected)

GYRO NG (Abnormal Optical Image Stabilizer
control)

1394

This is displayed when trouble has occurred in
the 1394 connections or signals.

1394 INITIAL ERROR (connection error)

1394 INPUT ERROR (input error)

1394 INPUT ERROR (OTHER FORMAT) (wrong
input format)

Screen displays (continued)

Setting the DISPLAY items

Display the following items on the viewfinder and LCD monitor screen by pressing the DISP/MODE CHK button or by configuring OTHER DISPLAY of the DISPLAY SETUP screen of the setup menus. (Page 110)

Displays	MODE CHECK	DISPLAY	OTHER DISPLAY settings		
			ALL	PARTIAL	OFF
1 Time code display	✓	—	—	—	—
3 AUTO/MANUAL switch operation display	✓	✓	✓	✓	x
5 Recording format	✓	✓	✓	x	x
7 Information display	✓	—	x	x	x
8 Squeeze information display	✓	✓	✓	✓	x
9 Microphone level auto-control display	✓	✓	✓	x	x
11 Focus bar display	—	—	—	—	—
13 Time stamp display	✓	✓*4	—	—	—
14 Calendar display	✓	✓*4	—	—	—
15 Recording/playback frame rate display	✓	✓	✓*1	x	x
16 Shutter speed display	✓	✓	✓	✓	x
17 Audio level meter display	✓	✓	—	—	—
18 Auto-IRIS control display	✓	✓	✓	✓	x
19 IRIS display	✓	✓	✓	✓	x
20 Zoom position display	✓	✓	—	—	—
21 Focus control display	✓	✓	—	—	—
23 Recommended ND filter display	✓	✓	✓	✓	x
24 ND filter display	✓	✓	✓	x	x
25 Gain display	✓	✓	✓	✓*2	x
27 AWB information display	✓	✓	✓	✓*3	x
28 Digital zoom display	✓	✓	—	—	—
30 Optical Image Stabilizer display	✓	✓	✓	✓	x
31 Scene file name	✓	✓	✓	x	x
32 Remaining battery display	✓	✓	—	—	—
33 Media remaining memory display	✓	✓	—	—	—
38 Safety zone display	—	—	—	—	—

✓: Displayed

x: Not displayed

—: Displayed depending on other settings

The item in ✓ in the MODE CHECK space appears when you press and hold the DISP/MODE CHK button. The item in ✓ in the DISPLAY space disappears when you press the DISP/MODE CHK button.

*1 Not displayed when FRAME RATE is set to 50i (60i).

*2 0 dB is not displayed.

*3 Only preset 3.2K and 5.6K are displayed.

*4 When both the “13 Time stamp display” and “14 Calendar display” are activated, the displays cannot be turned off by pressing the DISP/MODE CHK button.

Using the setup menus

Use the setup menus to change the settings to suit the scenes you are shooting or what you are recording.

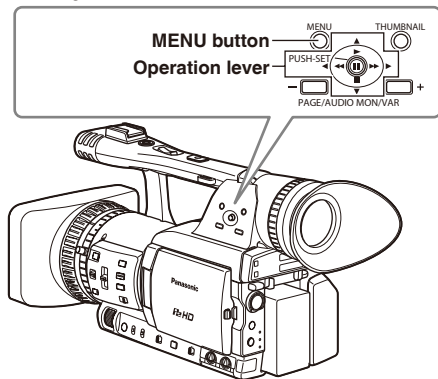

Using the menus

- If the thumbnail menu is displayed, press the THUMBNAIL button to release the display. (Page 67)
- The menu items indicated in the blue characters cannot be used.

- 1 When the unit is in other than playback or recording mode, press the MENU button. The following is displayed on the viewfinder and LCD screen.

CAM mode (Example)

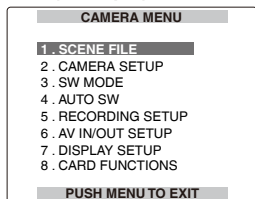

MCR mode (Example)

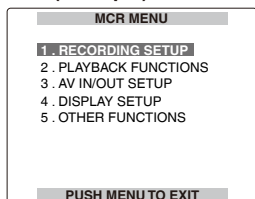

- 2 Push the Operation lever in the ▲ or ▼ direction to move the highlight to the setting you want.
- 3 Press the Operation lever (or push it in the ► direction) to display the items. Example:

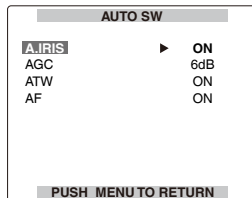

- 4 Push the Operation lever in the ▲ or ▼ direction to move to the setting you want. Example:

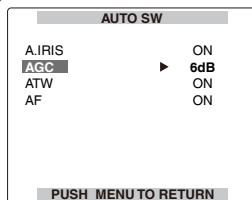

- 5 Press the Operation lever to confirm the setting.

To change a value, push the Operation lever in the ▲ or ▼ direction to change as necessary.

Example:

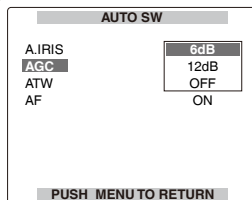

- 6 To change other settings, repeat steps 4 and 5.

When you finish, press the MENU button to return to the function screen.

- 7 To change other functions, repeat steps 2 to 5.

When you exit the menu mode, press the MENU button again to return to the normal screen.

Using the setup menus (continued)

Initializing the menu settings

The menu settings contain both the user file settings and the scene file settings. You can initialize them separately.

To initialize the user file (i.e. all the settings other than the scene file settings)

Select INITIAL in USER FILE of the OTHER FUNCTIONS screen. The current menu settings of user file will return to the factory settings.

To initialize the scene file

From the 6 scene files, select the one you want to initialize with the scene dial. Then in the SCENE FILE screen, LOAD/SAVE/INIT, select INITIAL. The settings for only the selected scene file are returned to the factory settings.

- This does not effect the other scene files.

To simultaneously initialize the user file and the scene files

Select YES under MENU INIT on the OTHER FUNCTIONS screen. This returns the user file and the 6 scene files to their factory settings.

Setup menu structure

CAM (camera) mode menu

CAMERA MENU

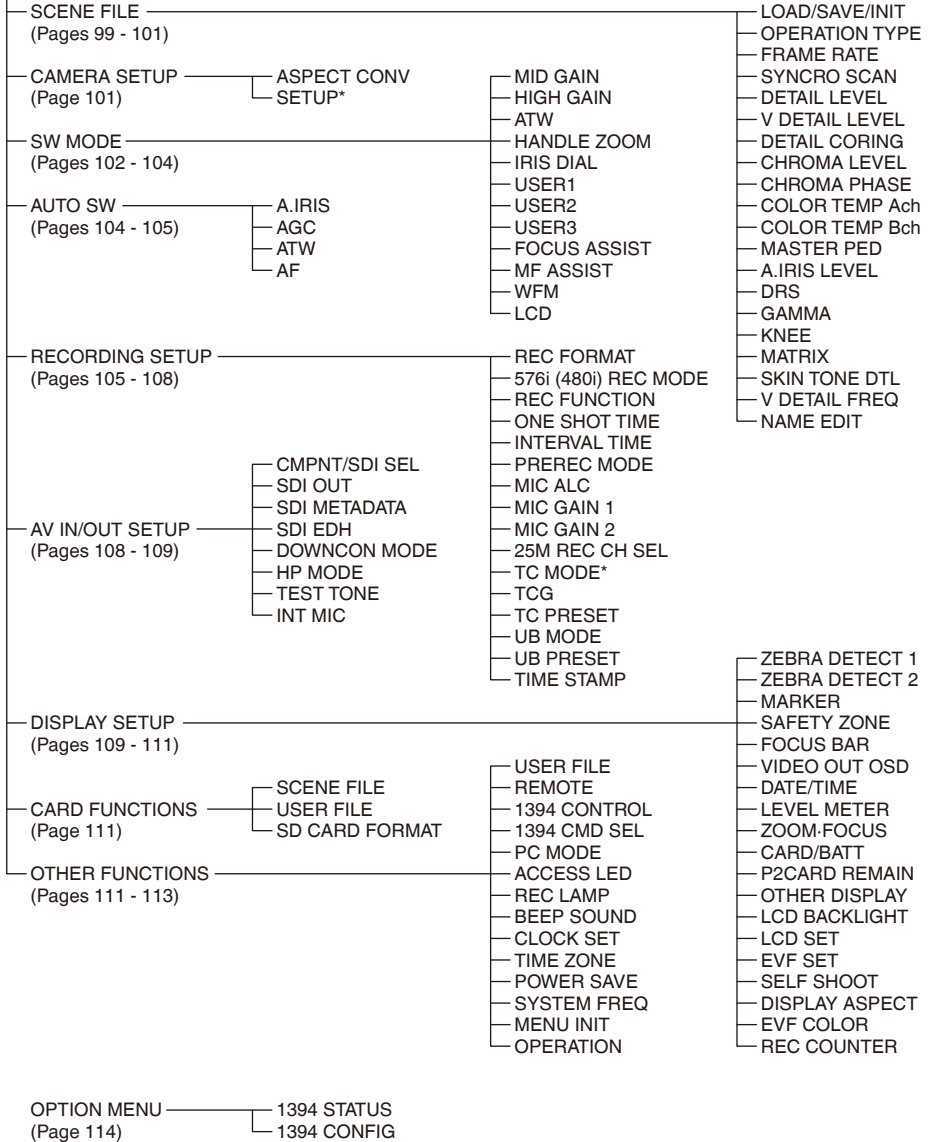

* Only when set to 59.94 Hz

Setup menu structure (continued)

MCR (playback) mode menu

MCR MENU

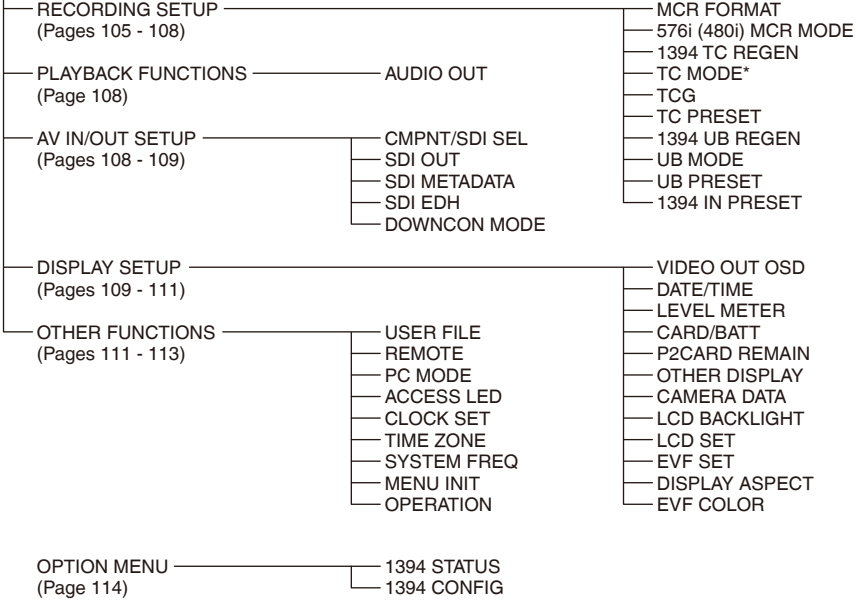

* Only when set to 59.94 Hz

Setup menu list

SCENE FILE screen

Item	Display mode	Description of settings
LOAD/SAVE/INIT	(Camera)	<p>LOAD: Loads the scene file settings saved using SAVE.</p> <p>SAVE: Saves the changed scene file settings.</p> <p>INITIAL: The settings of the scene file selected with the scene file dial are returned to the factory settings.</p>
OPERATION TYPE	(Camera)	<p>Switches the shutter and frame rate operation to the video type or film type.</p> <p>VIDEO CAM: SYNCRO SCAN is displayed using 1/n units.</p> <p>FILM CAM: SYNCRO SCAN is displayed as an angle.</p>
FRAME RATE	(Camera)	<p>Selects the shooting interval and exposure time when 720P and FILM CAM is selected. The DEFAULT value is dependent on the frame rate of the recording format.</p> <p>When SYSTEM FREQ is set to 50 Hz DEFAULT, 12, 15, 18, 20, 21, 22, 23, 24, 25, 26, 27, 28, 30, 32, 34, 37, 42, 45, 48, 50 FRAME</p> <p>When SYSTEM FREQ is set to 59.94 Hz DEFAULT, 12, 15, 18, 20, 21, 22, 24, 25, 26, 27, 28, 30, 32, 34, 36, 40, 44, 48, 54, 60 FRAME</p>
SYNCRO SCAN	(Camera)	<p>Adjusts the synchro scan shutter speed used for shooting images on a TV screen, etc.</p> <p>Pushing the Operation lever the ▲ or ▼ direction and holding it down will cause the values to change at a faster rate.</p> <p>When VIDEO CAM is selected as the OPERATION TYPE option setting:</p> <ul style="list-style-type: none"> • 50P/50i: 1/50.0...1/248.9 • 25P/25PN: 1/25.0...1/48.0...1/248.9 • 60P/60i: 1/60.0...1/249.8 • 30P/30PN: 1/30.0...1/48.0...1/249.8 • 24P/24PA/24PN: 1/24.0...1/48.0...1/249.8 <p>When FILM CAM is selected as the OPERATION TYPE option setting: The shutter speed is displayed as an angle such as "180.0 d." 10.0 deg...180.0 deg...360.0 deg (the angle can be changed in increments of 0.5 degrees)</p>
DETAIL LEVEL	(Camera)	<p>Adjusts the level of the image outline correction (in the horizontal and vertical directions).</p> <p>-7...0...+7</p>
V DETAIL LEVEL	(Camera)	<p>Adjusts the level of outline correction in the vertical direction.</p> <p>-7...0...+7</p>
DETAIL CORING	(Camera)	<p>Adjusts the level of noise reduction of the detail signal.</p> <p>-7...0...+7</p> <p>Set to – for a clearer image. Noise increases slightly. Set to + to reduce noise.</p>
CHROMA LEVEL	(Camera)	<p>Adjusts the chroma level.</p> <p>-7...0...+7</p>
CHROMA PHASE	(Camera)	<p>Makes fine adjustments to the chroma phase.</p> <p>-7...0...+7</p>
COLORTEMP Ach	(Camera)	<p>Makes fine adjustments to the color temperature (after white balance Ach adjustment).</p> <p>-7...0...+7</p>

Setup menu list (continued)

SCENE FILE screen (continued)

Item	Display mode	Description of settings
COLOR TEMP Bch	(Camera)	Makes fine adjustments to the color temperature (after white balance Bch adjustment). -7...0...+7
MASTER PED	(Camera)	Adjusts the master pedestal (black level of the image) as the basis for images. -100...0...+100
A.IRIS LEVEL	(Camera)	Sets the desired AUTO IRIS level. -10...0...+10
DRS	(Camera)	Selects the DRS (Dynamic Range Stretcher) function. This function compresses the video signal level to extend the dynamic range making it possible to correctly render highlight areas without overexposure and loss of detail that would otherwise occur. OFF, 1, 2, 3 <ul style="list-style-type: none"> • Larger values indicate a higher compression level of highlight areas. • Only effective in 50i (60i) and 50P (60P) VIDEO CAM. • In slow shutter mode, the options are shown in blue and you cannot make selection.
GAMMA	(Camera)	Selects gamma curve. HD NORM: This gamma setting is suitable for HD shooting. LOW: LOW: Makes a mellow image using the gamma curve which has a gentle incline in low-brightness curve. The contrast sharpens. SD NORM: This is the normal video setting, carried over from the DVX100 series. HIGH: Expands the tone of dark parts and makes a brighter image using the gamma curve which has a sharp incline in low-brightness curve. The contrast softens. B.PRESS: Makes the contrast sharper than LOW. CINE-LIKE_D: Makes a cinema-like image. CINE-LIKE_V: Makes a cinema-like image with emphasized contrast. When you select CINE-LIKE gamma, we recommend to set the lens aperture lower than normal image level (approximately 1/2) to enjoy the full benefit of the function.
KNEE	(Camera)	To avoid overexposure, select the compression level (knee point) of the high intensity video signals received through CCD. AUTO: Sets the level automatically according to the received signals. LOW: Low setting (Compression starts at approx. 80%.) MID: Medium setting (Compression starts at approx. 90%.) HIGH: High Setting (Compression starts at approx. 100%.)

SCENE FILE screen (continued)

Item	Display mode	Description of settings
MATRIX	(Camera)	Selects the MATRIX table suitable for the desired color expression during shooting. NORM1: Suitable for shooting in the open air or under a halogen lamp. NORM2: Suitable for brighter colors than the NORM1 mode. FLUO: Suitable for shooting under fluorescent light indoors. CINE-LIKE: Suitable for cinema-like image.
SKIN TONE DTL	(Camera)	Sets the skin tone details. Select ON to reduce the skin tone details and soften the skin tone. ON, OFF
V DETAIL FREQ	(Camera)	Sets the vertical detail for shooting in 576i (480i) progressive mode. THIN: Makes the detail thin. MID: Makes the detail slightly thicker. THICK: Makes the detail thicker. When images were shot in the progressive mode in which the vertical detail is set as "THIN" or "MID" and are played on a monitoring television (50i (60i) interlace), you will see flickers caused on horizontal lines and almost horizontal oblique lines. When playing back images in the progressive mode or when editing images or performing other postprocessing, images with a higher resolution will be obtained with the THIN or MID setting than with the THICK setting.
NAME EDIT	(Camera)	Edits the name of the selected scene file you have selected with the scene file dial.

CAMERA SETUP screen

Item	Display mode	Description of settings
ASPECT CONV	(Camera)	Selects the aspect ratio of the image you record in 576i (480i) format. This item cannot be selected when the 1080i or 720P recording format is used. (Page 42) SIDE CROP: Crops the right and left edges of the image. LETTER BOX: Adds black bands at the top and bottom of the image. SQUEEZE: Squeezes the image horizontally.
SETUP (Only when set to 59.94 Hz)	(Camera)	Switch the setup level of video signals in 480i format using a P2 card. 0%: Setup is switched to 0% for both the camera output and the recording. 7.5%A: Setup is switched to 7.5% for the camera output and 0% for the recording.

Setup menu list (continued)

SW MODE screen		
Item	Display mode	Description of settings
MID GAIN	(Camera)	Sets the gain value assigned to the M position of the GAIN switch. 0dB, 3dB, 6dB, 9dB, 12dB
HIGH GAIN	(Camera)	Sets the gain value assigned to the H position of the GAIN switch. 0dB, 3dB, 6dB, 9dB, 12dB
ATW	(Camera)	Sets the operation of the ATW (Auto Tracking White Balance) function assigned to the WHITE BAL switch. When the ATW function is set to the AUTO/MANUAL switch or USER button, the operation remains effective. Ach: Activates the ATW function when the WHITE BAL switch is set to A. Bch: Activates the ATW function when the WHITE BAL switch is set to B. PRST: Activates the ATW function when the WHITE BAL switch is set to PRST. OFF: Deactivates the ATW function.
HANDLE ZOOM	(Camera)	Sets the zoom speed assigned to each setting position of the HANDLE ZOOM switch. L/OFF/H: Sets LOW (low speed)/OFF/HIGH (high speed) to the 1/2/3 position. (Zoom is disabled when set to OFF.) L/M/H: Sets LOW (low speed)/MID (medium speed)/HIGH (high speed) to the 1/2/3 position. L/OFF/M: Sets LOW (low speed)/OFF/MID (medium speed) to the 1/2/3 position. (Zoom is disabled when set to OFF.)
IRIS DIAL	(Camera)	Sets the rotation direction and the aperture control of the IRIS dial. (In MANUAL IRIS mode) DOWN OPEN: The iris opens when the IRIS dial is turned downward. UP OPEN: The iris opens when the IRIS dial is turned upward.

SW MODE screen (continued)

Item	Display mode	Description of settings
USER1	(Camera)	<p>Selects the function assigned to the USER1 button.</p> <p>REC CHECK: Performs Rec Check.</p> <p>SPOTLIGHT: Auto iris control for the spotlight ON/OFF.</p> <p>BACKLIGHT: Auto iris control for the backlight compensation. (Page 43)</p> <p>BLACKFADE: Blackfade (Page 43)</p> <p>WHITEFADE: Whitefade (Page 43)</p> <p>ATW: ATW function ON/OFF.</p> <p>ATWLOCK: Fixes the white balance value when the button is pressed during ATW. Press again to perform ATW.</p> <p>GAIN: 18dB Press the button to set the gain value to 18 dB. This setting takes effect with the 50i (60i) and 50P (60P) recording formats only. It is not valid when the recording frame rate is less than 48 (54) fps or when the slow shutter mode (1/12 (1/15)) is established.</p> <ul style="list-style-type: none"> • When the gain value is set to 18 dB or set from 18 dB to another value, the image can be disordered for a moment. • If the unit is being used in the MANUAL mode or AUTO mode, set the AGC item on the AUTO SW screen of the setting menu to OFF to use this function. <p>D.ZOOM: Changes the ratio of the DIGITAL ZOOM function. Each press of the button changes the ratio in the following order: OFF (x1) → x2 → x5 → x10 → OFF (x1). (Page 30)</p> <p>TEXT MEMO: Records text memos (with P2 cards) (Page 45)</p> <p>SHOT MARK: Shot mark recording (Page 45)</p> <p>LVL METER: Switches the display channels of the audio level meter. (When Ch1/Ch2 and Ch3/Ch4 are displayed)</p> <p>LAST CLIP: Deletes the last recorded clip. (Page 46)</p> <p>PRE REC: Turns the PRE REC function ON or OFF.</p> <p>F.RATE+: Changes the frame rate.</p> <p>F.RATE-: Changes the frame rate.</p>
USER2	(Camera)	<p>Selects the function assigned to the USER2 button. The settings are the same as USER1 above.</p> <p>BACKLIGHT</p>
USER3	(Camera)	<p>Selects the function assigned to the USER3 button. The settings are the same as USER1 above.</p> <p>TEXT MEMO</p>

Setup menu list (continued)

SW MODE screen (continued)

Item	Display mode	Description of settings
FOCUS ASSIST	(Camera)	<p>Allocates a function to the FOCUS ASSIST button.</p> <p>EXPANDED: Magnifies the center portion of the image.</p> <p>GRAPH: Displays a frequency distribution graph at the top right in the viewfinder and LCD monitor.</p> <p>BOTH: Magnifies the center portion of the image and displays a histogram.</p>
MF ASSIST	(Camera)	<p>Automatically sets the last focus during manual focusing.</p> <p>ON: Automatically sets the last focus.</p> <ul style="list-style-type: none"> • The focus may not be set correctly if the last focus differs considerably from the manually set focus. • You cannot operate using the remote control connected to the CAM REMOTE jack. <p>OFF: The focus is not adjusted automatically.</p>
WFM	(Camera)	<p>Switches the waveform display that appears when the WFM button is pressed.</p> <p>WAVE: Displays a waveform.</p> <p>VECTOR: Opens a vector display.</p> <p>WAVE/VECT: Each press of the button, switches the settings in the following order: OFF → WAVE (waveform) → VECTOR (vector) → OFF.</p>
LCD	(Camera)	<p>Allocates a function to the LCD button.</p> <p>LCD REV: Flips the LCD image vertically and horizontally.</p> <p>OVERSCAN: Switches between overscan and underscan of the LCD/viewfinder image. This button toggles between the overscan and underscan image at each press.</p> <p>LCD BL: Switches the brightness of the LCD backlight.</p> <ul style="list-style-type: none"> • The brightness of the backlight set using LCD BL is retained when functions assigned using the LCD button change.

AUTO SW screen

Item	Display mode	Description of settings
A.IRIS	(Camera)	<p>ON: Performs the auto iris control in auto mode. The IRIS button is deactivated.</p> <p>OFF: Deactivates the auto iris control in auto mode. This performs the iris control selected with the IRIS button.</p>

AUTO SW screen (continued)

Item	Display mode	Description of settings
AGC	(Camera)	Sets the Auto Gain Control when the ON is selected in A.IRIS. 6dB: Performs the Auto Gain Control (max. 6 dB) in auto mode. 12dB: Performs the Auto Gain Control (max. 12 dB) in auto mode. OFF: Does not perform the Auto Gain Control in auto mode. Initiates the control of the gain selected by the GAIN switch.
ATW	(Camera)	ON: Performs the ATW (Auto Tracing White Balance) function in auto mode. You cannot select ON/OFF of the ATW function with the WHITE BAL switch or the USER button when this is selected. However, if ATWLOCK is assigned to the USER button, you can set the white balance value with the USER button. OFF: Does not perform the white balance function in auto mode. This performs the white balance function selected with the WHITE BAL switch.
AF	(Camera)	ON: Performs auto focusing in auto mode. You cannot use the FOCUS switch and PUSH AUTO button when this is selected. OFF: Does not perform auto focusing in auto mode. This performs the focusing selected with the FOCUS switch or PUSH AUTO button.

RECORDING SETUP screen

Item	Display mode	Description of settings
REC FORMAT	(Camera)	Selects the recording format. When SYSTEM FREQ is set to 50 Hz <u>1080i/50i, 1080i/25P, 720P/50P, 720P/25P, 720P/25PN, 576i/50i, 576i/25P</u> When SYSTEM FREQ is set to 59.94 Hz <u>1080i/60i, 1080i/30P, 1080i/24P, 1080i/24PA, 720P/60P, 720P/30P, 720P/24P, 720P/30PN, 720P/24PN, 480i/60i, 480i/30P, 480i/24P, 480i/24PA</u>
MCR FORMAT	(MCR)	Selects playback or a 1394 input format. When SYSTEM FREQ is set to 50 Hz: <u>1080i/50i, 720P/50P, 720P/25PN, 576i/50i</u> When SYSTEM FREQ is set to 59.94 Hz: <u>1080i/60i, 720P/60P, 720P/30PN, 720P/24PN, 480i/60i</u>
576i (480i) REC MODE	(Camera)	Select the recording mode for a 576i (480i) recording format. DVCPRO50, DVCPRO, DV
576i (480i) MCR MODE	(MCR)	Selects format for playback or 1394 input in the 576i (480i) recording format. DVCPRO50, DVCPRO, DV
REC FUNCTION	(Camera)	Selects the special recording mode. (Pages 47 - 49) NORMAL, INTERVAL, ONE SHOT, LOOP
ONE-SHOT TIME	(Camera)	Selects the one-shot recording time. (Page 48) 1F, 2F, 4F, 8F, 16F, 1s
INTERVAL TIME	(Camera)	Selects the interval time for interval recording. (Page 47) 2F, 4F, 8F, 16F, 1s, 2s, 5s, 10s, 30s, 1m, 5m, 10m
PREREC MODE	(Camera)	Sets PRE RECORDING to ON or OFF. (Page 47) ON, OFF

Setup menu list (continued)

RECORDING SETUP screen (continued)

Item	Display mode	Description of settings
MIC ALC	(Camera)	Sets mic level auto control to ON or OFF. (Page 53) ON, OFF Set to ON to reduce distortion at high input levels. This setting does not change the audio signal recording level. Use the AUDIO control knob to adjust the audio signal recording level.
MIC GAIN 1	(Camera)	Sets the input level of the external microphone connected to the INPUT 1 terminal. (Page 52) -50dB, -60dB
MIC GAIN 2	(Camera)	Sets the input level of the external microphone connected to the INPUT 2 terminal. (Page 52) -50dB, -60dB
25M REC CH SEL	(Camera)	Selects the recording audio channel for DVCPRO and DV formats. (Page 52) 2CH, 4CH <Notes> <ul style="list-style-type: none"> • Even when 4CH is selected as this item's setting, the signals will be input to two channels (always CH1 and CH2) when there are two 1394 input channels. • Similarly, even when 4CH is selected, the 1394 output signals will be delivered to two channels (always CH1 and CH2).
1394 TC REGEN	(MCR)	Selects the time code used for recording the signal from equipment connected to the 1394 terminal. ON: Records using the time code of the signal input through the 1394 terminal. OFF: Records using the time code set in TC MODE/TCG. <ul style="list-style-type: none"> • If you select ON here, this has priority over the settings in TC MODE/TCG. • If there is no input to the 1394 terminal, the camera follows the settings in TC MODE/TCG.
TC MODE (Only when set to 59.94 Hz)	(Camera) (MCR)	Selects the correction mode of the internal time code generator. DF: Uses the drop frame mode. NDF: Uses the non-drop frame mode. <ul style="list-style-type: none"> • The non-drop frame mode will be used when you set recording frame rate of recording format to 24P, 24PA or 24PN.
TCG	(Camera) (MCR)	Sets the mode in which you advance the time code. FREE RUN: The time code is advanced regardless of the operation mode. <ul style="list-style-type: none"> • When setting a frame rate other than 25P (24P) during operation with the 720P/25PN (720P/24PN) format, the FREE RUN operation for the time code will not be performed, and the REC RUN operation will be performed instead. It is the same when setting a frame rate other than 30P during operation with the 720P/30PN format. REC RUN: The time code is advanced only when recording.
TC PRESET	(Camera) (MCR)	Sets the initial time code. <ul style="list-style-type: none"> • Set the frame value to 0 or a multiple of 5 when you set recording frame rate of recording format to 24P, 24PA or 24PN. If any other value, the recorded time code will mis-match.

RECORDING SETUP screen (continued)

Item	Display mode	Description of settings
1394 UB REGEN	(MCR)	<p>Selects the user information used when recording the signals from equipment connected to the 1394 terminal.</p> <p>ON: Records using the user information of the signal input through the 1394 terminal.</p> <p>OFF: Records using the user information set in UB MODE.</p> <ul style="list-style-type: none"> • If you select ON here, this has priority over the setting in UB MODE. • The user information is recorded only when the signal contains the user information. • If there is no input to the 1394 terminal, the camera follows the UB MODE settings.
UB MODE	(Camera) (MCR)	<p>Set the content for user information.</p> <p>USER: Records the information of user.</p> <p>TIME: Records the time at recording.</p> <p>DATE: Records the date at recording.</p> <p>TCG: Records the values of the time code generator.</p> <p>FRM. RATE: Records the frame rate information for frame conversion.</p> <div style="text-align: center;"> <pre> * * 0 * * * * a b c d </pre> </div> <p>a: Checking information for user information</p> <p>b: Frame sequence No.</p> <p>When SYSTEM FREQ is set to 50 Hz:</p> <ul style="list-style-type: none"> • F is displayed. <p>When SYSTEM FREQ is set to 59.94 Hz:</p> <ul style="list-style-type: none"> • 0 to 4 are displayed in the 24P/24P (advanced) mode. • F is displayed in the 60i/30P mode. <p>c: Frame rates</p> <ul style="list-style-type: none"> • Frame rate (50/25 (60/30/24)) • I/P ID • Conversion data • Frame rate coefficient <p>d: Recording management data</p> <ul style="list-style-type: none"> • Frame update information • REC START/STOP information <p><Note></p> <p>To play back a clip recorded with native recording To change 1394 output user information to frame rate information, change this setting to FRM.RATE and play back the clip. The user information displayed on the screen at this time is changed to frame rate information.</p>
UB PRESET	(Camera) (MCR)	Sets the user information. Select USER in UB MODE.
1394 IN PRESET	(MCR)	<p>Synchronizes the internal TCG value with the TC of 1394 input when you press the TC SET button.</p> <p>ON: The synchronization mode is on.</p> <p>OFF: The synchronization mode is off.</p>

Setup menu list (continued)

RECORDING SETUP screen (continued)

Item	Display mode	Description of settings
TIME STAMP	(Camera)	Determines whether or not date and time information will be superimposed on the image. ON: Superimposes date and time information on the image. OFF: Does not superimpose date and time information on the image. <Note> When DATE/TIME on the DISPLAY SETUP screen is set to OFF, the date and time information is not superimposed.

PLAYBACK FUNCTIONS screen

Item	Display mode	Description of settings
AUDIO OUT	(MCR)	Sets the audio signals to output from the AUDIO OUT pin jack when the P2 card or the tape is played back. CH1 - CH2: CH1 output = CH1 signals, CH2 output = CH2 signals CH1: CH1 output = CH1 signals, CH2 output = CH1 signals CH2: CH1 output = CH2 signals, CH2 output = CH2 signals CH3 - CH4: CH1 output = CH3 signals, CH2 output = CH4 signals CH3: CH1 output = CH3 signals, CH2 output = CH3 signals CH4: CH1 output = CH4 signals, CH2 output = CH4 signals

AV IN/OUT SETUP screen

Item	Display mode	Description of settings
CMPNT/SDI SEL	(Camera) (MCR)	Selects the type of component terminal or SDI connector. When SYSTEM FREQ is set to 50 Hz: AUTO: Monitor with D4 terminal (720P/1080i/576i output) 1080i: Monitor with D3 terminal (1080i/576i output) 576i: Monitor with D1 terminal (576i output) When SYSTEM FREQ is set to 59.94 Hz: AUTO: Monitor with D4 terminal (720P/1080i/480i output) 1080i: Monitor with D3 terminal (1080i/480i output) 480i: Monitor with D1 terminal (480i output) Only video recorded at 720P is cross-converted to 1080i. Cross-conversion does not take place in other cases.
SDI OUT	(Camera) (MCR)	Selects video output from component terminal or SDI OUT terminal. ON: Video is not output via the component terminal but from the SDI connector. OFF: Video is output via the component terminal but not from the SDI connector.
SDI METADATA	(Camera) (MCR)	Determines whether or not metadata is superimposed on SDI signals during HD-SDI output. ON: Superimposes metadata. OFF: Does not superimpose metadata.
SDI EDH	(Camera) (MCR)	Determines whether or not EDH is superimposed on SD-SDI signals during SD-SDI output. ON: Superimposes EDH. OFF: Does not superimpose EDH.

AV IN/OUT SETUP screen (continued)

Item	Display mode	Description of settings
DOWNCON MODE	(Camera) (MCR)	Switches down-conversion output mode. SIDE CROP: Crops the right and left edges of the images with the 4:3 aspect ratio. LETTER BOX: Adds black bands at the top and bottom of the images, and the images with the 16:9 aspect ratio are displayed in the 4:3 aspect ratio. SQUEEZE: Select this option for 16:9 aspect ratio images. When viewed on a 4:3 aspect ratio monitor, images are squeezed horizontally.
HP MODE	(Camera)	Selects the sound heard through the headphones. LIVE: The sound which has been input from the microphone is output as is. This setting is selected when delays in the sound are annoying. RECORDING: The sound in the status which is to be recorded (the sound synchronized with the images) is output.
TEST TONE	(Camera)	Determines whether or not a test tone is output to channels 1, 2, 3 and 4 when BARS is set to ON. ON: Outputs a test tone to channels 1, 2, 3 and 4. OFF: Does not output a test tone.
INT MIC	(Camera)	Determines whether or not input from the internal microphone is used during recording. ON: Uses internal microphone input. OFF: Does not use internal microphone input.

DISPLAY SETUP screen

Item	Display mode	Description of settings
ZEBRA DETECT 1	(Camera)	Selects the brightness level of the left-leaning zebra patterns on the screen. 50%, 55%, 60%, 65%, 70%, 75%, 80%, 85%, 90%, 95%, 100%, 105%
ZEBRA DETECT 2	(Camera)	Selects the brightness level of the right-leaning zebra patterns on the screen. 50%, 55%, 60%, 65%, 70%, 75%, 80%, 85%, 90%, 95%, 100%, 105%, OFF <Note> The zebra patterns do not appear if you select OFF.
MARKER	(Camera)	Select ON to display the marker. (Page 41) ON, OFF To display the marker, press the ZEBRA button.
SAFETY ZONE	(Camera)	Sets SAFETY ZONE to ON or OFF. OFF, 90%, 4:3, 13:9, 14:9
FOCUS BAR	(Camera)	Turns the FOCUS ASSIST bar display ON or OFF. ON, OFF When set to ON, the FOCUS ASSIST bar can be displayed.
VIDEO OUT OSD	(Camera) (MCR)	Select ON to output the information displayed on the screen together with the signals from the VIDEO IN/OUT jack. ON, OFF

Setup menu list (continued)

DISPLAY SETUP screen (continued)

Item	Display mode	Description of settings
DATE/TIME	(Camera) (MCR)	Sets whether to display the date and time on the screen and whether to output from the VIDEO IN/OUT jack. OFF: The date and time are not displayed. TIME: The time is displayed. DATE: The date is displayed. TIME&DATE: The time and date are displayed.
LEVEL METER	(Camera) (MCR)	Select ON to display the audio level meter. ON OFF
ZOOM-FOCUS	(Camera)	Selects the unit of zoom and focus values. OFF, NUMBER, mm/feet, mm/m <Note> Use the mm/feet or mm/m display only as a general guideline since it is not entirely accurate.
CARD/BATT	(Camera) (MCR)	Select ON to display the remaining P2 card recording capacity and remaining battery charge. ON, OFF
P2CARD REMAIN	(Camera) (MCR)	Determines how remaining P2 card capacity is displayed. ONE-CARD: Displays how much space is left on the P2 card that is currently being recorded. TOTAL: Displays the total amount of space that is left on P2 cards inserted in the camera.
OTHER DISPLAY	(Camera) (MCR)	Select how much information to display on the screen. (Page 94) OFF, PARTIAL, ALL
CAMERA DATA	(MCR)	When set to ON, camera-recorder data (image stabilizer, aperture, gain value) made during shooting is displayed in playback of clips recorded in the DV format. ON, OFF <Note> Appears only when 576i (480i) REC MODE (Page 105) is set to DV.
LCD BACKLIGHT	(Camera) (MCR)	Adjusts the backlight of the LCD monitor. Select HIGH for brighter backlight. HIGH, NORMAL, LOW
LCD SET	(Camera) (MCR)	Adjusts the display level of the images on the LCD monitor. (Page 22) LCD COLOR LEVEL, LCD BRIGHTNESS, LCD CONTRAST
EVF SET	(Camera) (MCR)	Adjusts the display level of the images on the viewfinder. (Page 22) EVF COLOR LEVEL, EVF BRIGHTNESS, EVF CONTRAST
SELF SHOOT	(Camera)	Selects the LCD mirror mode for self-portrait shooting. Select MIRROR to reverse left and right at self-portrait shooting. (Page 41) NORMAL, MIRROR
DISPLAY ASPECT	(Camera) (MCR)	Selects the aspect ratio of the LCD monitor and the viewfinder. AUTO: Changes automatically to the appropriate ratio according to the recording or play mode information. 4:3: Fixed at 4:3. <Note> Black bands appear at the top and bottom of the screen when images are displayed at a 16:9 aspect ratio. No parts of the images are missing.
EVF COLOR	(Camera) (MCR)	Selects color or black and white images on the viewfinder. ON: Color OFF: Black and white

DISPLAY SETUP screen (continued)

Item	Display mode	Description of settings
REC COUNTER	(Camera)	Selects counter operation during recording. TOTAL: Continues counting until card is reset with the COUNTER RESET button. CLIP: Resets the counter at start of recording and counts the time of each recording session.

CARD FUNCTIONS screen

Item	Display mode	Description of settings
SCENE FILE	(Camera)	Reads/writes scene files from/to the SD memory card. FILE SELECT: You can specify the file numbers of the files to be read/written. READ: You can read the setting values of the scene files (1 to 4) from the SD memory card by specifying the file number. WRITE: Saves the current setting values of the scene files (1 to 4) to the SD memory card. TITLE RELOAD: Updates the title list.
USER FILE	(Camera)	Reads/writes user files (excluding scene files) from/to the SD memory card. FILE SELECT: You can specify the file numbers of the files to be read/written. READ: You can read the setting values of the user files (1 to 4) from the SD memory card by specifying the file number. WRITE: Saves the current setting values of the user files (1 to 4) to the SD memory card. TITLE RELOAD: Updates the title list.
SD CARD FORMAT	(Camera)	Formats the SD memory cards.

OTHER FUNCTIONS screen

Item	Display mode	Description of settings
USER FILE	(Camera) (MCR)	LOAD: Loads the settings in a previously stored user file. SAVE: Saves the updated user file settings. INITIAL: Returns the user settings in the user file to the factory settings. After a LOAD or INITIAL operation, turn the POWER switch off and then back on again to make the new settings available. • An INITIAL operation does not change the TIME ZONE settings (Page 113).
REMOTE	(Camera) (MCR)	Sets the operations of the supplied remote control unit. (Remote control setup. (Page 18)) OFF: Operations are not accepted from any remote control. 1: Accepts commands from the remote control set for "operation mode 1" 2: Accepts commands from the remote control set for "operation mode 2".

Setup menu list (continued)

OTHER FUNCTIONS screen (continued)

Item	Display mode	Description of settings
1394 CONTROL	(Camera)	<p>Sets the control method for backup recording using a backup unit connected to the 1394 terminal.</p> <p>OFF: The backup unit is not controlled.</p> <p>EXT: The backup unit can be controlled by the START/STOP button. The images shot by the camera recorder are recorded by the backup unit. Note that the camera recorder does not record them.</p> <p>BOTH: The images shot by the camera recorder are recorded by both the camera recorder and backup unit.</p> <p>CHAIN: When the camera recorder's media approaches its end during shooting, the backup unit in the recording stand-by mode automatically starts recording images.</p>
1394 CMD SEL	(Camera)	<p>Sets how the START/STOP button works for the backup unit.</p> <p>REC P: This switches between recording and pause.</p> <p>STOP: This switches between recording and stop.</p> <p><Note> If the backup unit does not have a rec pause function, select STOP.</p>
PC MODE	(Camera) (MCR)	<p>Selects the terminal for data transfer. (You cannot select USB and 1394 at the same time.)</p> <p>USB DEVICE: Mode for sending files using the USB connector.</p> <p>1394 DEVICE: Mode for sending files using the 1394 connector.</p> <p>1394 HOST: Mode for copying files from the P2 card onto an external hard disk drive using the 1394 connector.</p>
ACCESS LED	(Camera) (MCR)	<p>Sets the access lamp to ON or OFF.</p> <p>ON: The lamp lights up and blinks as per the regular specifications.</p> <p>OFF: The lamp is OFF in all circumstances.</p>
REC LAMP	(Camera)	<p>Sets lighting of the tally lamp.</p> <p>OFF: The tally lamp does not light.</p> <p>FRONT: Front tally lamp (microphone side) lights.</p> <p>REAR: Rear tally lamp (viewfinder side) lights.</p> <p>BOTH: Both tally lamps light.</p>
BEEP SOUND	(Camera)	<p>Turns the beep sound ON or OFF.</p> <p>ON, OFF When ON is selected, the beep is sounded when the memory of the P2 card has been used up during recording. When the beep is sounded, the audio signals from the output connector are muted before the beep sound is output.</p>
CLOCK SET	(Camera) (MCR)	<p>Sets the camera-recorder's calendar.</p>

OTHER FUNCTIONS screen (continued)

Item	Display mode	Description of settings																																																																																																												
TIME ZONE	(Camera) (MCR)	<p>Adds to or deducts from GMT the time value of -12:00 to +13:00 in 30-minute steps. (As an exception, you can set +12:45.) Refer to the table below.</p> <p>0:00</p> <table border="1"> <thead> <tr> <th>Time difference</th> <th>Area</th> <th>Time difference</th> <th>Area</th> </tr> </thead> <tbody> <tr> <td>00:00</td> <td>Greenwich</td> <td>- 00:30</td> <td></td> </tr> <tr> <td>- 01:00</td> <td>Azores Islands</td> <td>- 01:30</td> <td></td> </tr> <tr> <td>- 02:00</td> <td>Mid-Atlantic</td> <td>- 02:30</td> <td></td> </tr> <tr> <td>- 03:00</td> <td>Buenos Aires</td> <td>- 03:30</td> <td>Newfoundland Island</td> </tr> <tr> <td>- 04:00</td> <td>Halifax</td> <td>- 04:30</td> <td></td> </tr> <tr> <td>- 05:00</td> <td>New York</td> <td>- 05:30</td> <td></td> </tr> <tr> <td>- 06:00</td> <td>Chicago</td> <td>- 06:30</td> <td></td> </tr> <tr> <td>- 07:00</td> <td>Denver</td> <td>- 07:30</td> <td></td> </tr> <tr> <td>- 08:00</td> <td>Los Angeles</td> <td>- 08:30</td> <td></td> </tr> <tr> <td>- 09:00</td> <td>Alaska</td> <td>- 09:30</td> <td>Marquesas Islands</td> </tr> <tr> <td>- 10:00</td> <td>Hawaii</td> <td>- 10:30</td> <td></td> </tr> <tr> <td>- 11:00</td> <td>Midway Island</td> <td>- 11:30</td> <td></td> </tr> <tr> <td>- 12:00</td> <td>Kwajalein</td> <td>+ 11:30</td> <td>Norfolk Island</td> </tr> <tr> <td>+ 13:00</td> <td></td> <td>+ 10:30</td> <td>Lord Howe Island</td> </tr> <tr> <td>+ 12:00</td> <td>New Zealand</td> <td>+ 09:30</td> <td>Darwin</td> </tr> <tr> <td>+ 11:00</td> <td>Solomon Islands</td> <td>+ 08:30</td> <td></td> </tr> <tr> <td>+ 10:00</td> <td>Guam</td> <td>+ 07:30</td> <td></td> </tr> <tr> <td>+ 09:00</td> <td>Tokyo</td> <td>+ 06:30</td> <td>Rangoon</td> </tr> <tr> <td>+ 08:00</td> <td>Beijing</td> <td>+ 05:30</td> <td>Bombay</td> </tr> <tr> <td>+ 07:00</td> <td>Bangkok</td> <td>+ 04:30</td> <td>Kabul</td> </tr> <tr> <td>+ 06:00</td> <td>Dacca</td> <td>+ 03:30</td> <td>Tehran</td> </tr> <tr> <td>+ 05:00</td> <td>Islamabad</td> <td>+ 02:30</td> <td></td> </tr> <tr> <td>+ 04:00</td> <td>Abu Dhabi</td> <td>+ 01:30</td> <td></td> </tr> <tr> <td>+ 03:00</td> <td>Moscow</td> <td>+ 00:30</td> <td></td> </tr> <tr> <td>+ 02:00</td> <td>Eastern Europe</td> <td>+ 12:45</td> <td>Chatham Islands</td> </tr> <tr> <td>+ 01:00</td> <td>Central Europe</td> <td></td> <td></td> </tr> </tbody> </table>	Time difference	Area	Time difference	Area	00:00	Greenwich	- 00:30		- 01:00	Azores Islands	- 01:30		- 02:00	Mid-Atlantic	- 02:30		- 03:00	Buenos Aires	- 03:30	Newfoundland Island	- 04:00	Halifax	- 04:30		- 05:00	New York	- 05:30		- 06:00	Chicago	- 06:30		- 07:00	Denver	- 07:30		- 08:00	Los Angeles	- 08:30		- 09:00	Alaska	- 09:30	Marquesas Islands	- 10:00	Hawaii	- 10:30		- 11:00	Midway Island	- 11:30		- 12:00	Kwajalein	+ 11:30	Norfolk Island	+ 13:00		+ 10:30	Lord Howe Island	+ 12:00	New Zealand	+ 09:30	Darwin	+ 11:00	Solomon Islands	+ 08:30		+ 10:00	Guam	+ 07:30		+ 09:00	Tokyo	+ 06:30	Rangoon	+ 08:00	Beijing	+ 05:30	Bombay	+ 07:00	Bangkok	+ 04:30	Kabul	+ 06:00	Dacca	+ 03:30	Tehran	+ 05:00	Islamabad	+ 02:30		+ 04:00	Abu Dhabi	+ 01:30		+ 03:00	Moscow	+ 00:30		+ 02:00	Eastern Europe	+ 12:45	Chatham Islands	+ 01:00	Central Europe		
Time difference	Area	Time difference	Area																																																																																																											
00:00	Greenwich	- 00:30																																																																																																												
- 01:00	Azores Islands	- 01:30																																																																																																												
- 02:00	Mid-Atlantic	- 02:30																																																																																																												
- 03:00	Buenos Aires	- 03:30	Newfoundland Island																																																																																																											
- 04:00	Halifax	- 04:30																																																																																																												
- 05:00	New York	- 05:30																																																																																																												
- 06:00	Chicago	- 06:30																																																																																																												
- 07:00	Denver	- 07:30																																																																																																												
- 08:00	Los Angeles	- 08:30																																																																																																												
- 09:00	Alaska	- 09:30	Marquesas Islands																																																																																																											
- 10:00	Hawaii	- 10:30																																																																																																												
- 11:00	Midway Island	- 11:30																																																																																																												
- 12:00	Kwajalein	+ 11:30	Norfolk Island																																																																																																											
+ 13:00		+ 10:30	Lord Howe Island																																																																																																											
+ 12:00	New Zealand	+ 09:30	Darwin																																																																																																											
+ 11:00	Solomon Islands	+ 08:30																																																																																																												
+ 10:00	Guam	+ 07:30																																																																																																												
+ 09:00	Tokyo	+ 06:30	Rangoon																																																																																																											
+ 08:00	Beijing	+ 05:30	Bombay																																																																																																											
+ 07:00	Bangkok	+ 04:30	Kabul																																																																																																											
+ 06:00	Dacca	+ 03:30	Tehran																																																																																																											
+ 05:00	Islamabad	+ 02:30																																																																																																												
+ 04:00	Abu Dhabi	+ 01:30																																																																																																												
+ 03:00	Moscow	+ 00:30																																																																																																												
+ 02:00	Eastern Europe	+ 12:45	Chatham Islands																																																																																																											
+ 01:00	Central Europe																																																																																																													
POWER SAVE	(Camera)	<p>Selects the power-saving mode when the Operation lever, MENU button, THUMBNAIL button, PAGE/AUDIO MON/VAR button, DISP/MODE CHK button, USER1-3 buttons and EVF DTL button have not been operated for 5 minutes or so.</p> <p>ON: The camera-recorder's power is set to OFF.</p> <p>OFF: The unit remains stopped without turning off its power.</p> <ul style="list-style-type: none"> When connection is made with an external device using the 1394 cable and the communication mode is established in this way, the power will not be set off even when none of the above buttons has been operated. The power will not be turned off when a P2 card has not been installed, even if ON has been selected. 																																																																																																												
SYSTEM FREQ	(Camera) (MCR)	<p>Switches the system frequency.</p> <p>59.94 Hz, 50 Hz</p>																																																																																																												
MENU INIT	(Camera) (MCR)	<p>Returns the menu settings to the factory settings.</p> <ul style="list-style-type: none"> The time zone setting will not be changed. 																																																																																																												
OPERATION	(Camera) (MCR)	<p>Displays the power-on time (a 5-digit figure).</p>																																																																																																												

Setup menu list (continued)

OPTION MENU screen

This menu is displayed when the DISP/MODE CHK button is held down, and after the details of the shooting status are displayed, the MENU button is then pressed. Use it to check the connection status during nonlinear editing.

Item	Display mode	Description of settings
1394 STATUS	(Camera) (MCR)	1394 status display screen appears. FORMAT: Format of the signals which are input or output. RATE: Transfer rate of the signals which are input or output. 60/50: System of the signals which are input or output. CH: Value of the channels in which the signals are input or output. SPEED: Transfer speed of the signals which are input or output. STATUS: Status of the signals which are input or output using the 1394 digital interface. VIDEO: Status of the video signals which are input or output. AUDIO: Status of the audio signals which are input or output.
1394 CONFIG	(Camera) (MCR)	1394 extended menus appear. DFLT: Normally, DFLT is used. 1-255

Before calling for service

Power supply

There's no power.	<ul style="list-style-type: none"> • Make sure the battery and AC adapter are connected properly. Check the connections again. 	P16
Power shuts off for no apparent reason.	<ul style="list-style-type: none"> • To prevent the battery from running down needlessly, the camera-recorder automatically turns off when the camera-recorder has been left in the shooting pause mode for more than 5 minutes. Check the settings in the OTHER FUNCTIONS screen, POWER SAVE. 	P113
Power goes off as soon as it is turned on.	<ul style="list-style-type: none"> • The battery may have run out. If the remaining battery charge display is blinking or <input type="checkbox"/> appears, the battery has run out. The same is true if, when the power is turned on, the CAM, MCR and PC lamps flash in this sequence and then the power goes off. Either recharge the battery or replace the discharged battery with a fully charged one. 	P15

Battery

The battery runs down quickly.	<ul style="list-style-type: none"> • Make sure the battery is fully charged. Keep charging until the AC adapter's CHARGE lamp goes out. • Are you using the battery in a cold place? The battery is affected by the ambient temperature. Its operating time is reduced in low-temperatures. • The battery may have reached the end of its service life. The battery will become unchargeable. The battery has a certain service life which varies depending on how the battery is used. If the battery operates only for a short period even when it is charged adequately, it has reached the end of its service life. 	P15 — —
The battery cannot be charged.	<ul style="list-style-type: none"> • The battery cannot be charged if the DC cord is connected. Disconnect it. 	—

Before calling for service (continued)

Shooting

Cannot start shooting.	<ul style="list-style-type: none"> • Make sure the POWER switch is ON. 	P19
Cannot focus automatically.	<ul style="list-style-type: none"> • You can focus automatically when the auto focus mode is selected. • You may be shooting a scene where it is difficult to bring the subject into focus in the auto focus mode. If this is the case, focus in the manual focus mode. It may be hard to bring the subject into focus when <ul style="list-style-type: none"> · both close and distant objects are to be shot · shooting through a dirty window · shooting in a dark place · there are sparkling or shiny objects around the subject · the subject is moving fast · shooting a scene with minimal contrast 	P36 —
Cannot shoot even though the P2 card is inserted correctly.	<ul style="list-style-type: none"> • Make sure the P2 card's write-protect switch is not in the PROTECT position. Recording is not possible if it is in this position. • There may be little free memory left on the P2 card. If so, save the data onto another media, and delete the data you no longer need; alternatively, replace the card with a new one. • The P2 card may be formatted incorrectly. Alternatively, the card you are using may not be formatted for use with the unit. If so, format the card in the unit. • 2 GB P2 cards cannot be used. • The media information display may be indicating "E". If so, format the card in the unit. 	P26 — P26 — P91
Cannot perform interval recording, one-shot recording or loop recording.	<ul style="list-style-type: none"> • Make sure that the DIR ENTRY NG CARD warning is not displayed after inserting the P2 card. Interval recording, one-shot recording and loop recording cannot be performed with this card. Format the card in the unit. 	P92

Editing

Cannot perform nonlinear editing.	<ul style="list-style-type: none"> • Check the specifications of your computer and connecting cable. 	P82
Cannot dub onto an external device.	<ul style="list-style-type: none"> • Make sure the external device is connected correctly. 	P79 - 81

Displays

Something is wrong with the time code display.	<ul style="list-style-type: none"> • The time code display may not register a regular count if a tape is played in the reverse slow mode. This is normal. 	—
--	--	---

Playback

Cannot play even when I press the play button.	<ul style="list-style-type: none"> Make sure the MCR lamp is on (press the mode button). No kind of playback operation can be performed unless this lamp is on. 	P64
Mosaic-like noise appears when I cue or review a tape.	<ul style="list-style-type: none"> This noise is inherent to digital video technology. This is normal. 	—
Images do not appear on the television even though I have connected the camera-recorder properly.	<ul style="list-style-type: none"> Make sure the input selector on your television is set to video input. Read the television's instructions carefully and select the correct video input connector for the camera-recorder. 	—
Cannot hear any sound from the camera-recorder's speaker.	<ul style="list-style-type: none"> You may have turned down the camera-recorder's volume control too far. Adjust the volume level using the PAGE/AUDIO MON/ VAR button+. 	P76
Cannot perform hot swap playback.	<ul style="list-style-type: none"> This unit does not support hot swap playback. To replace one card with another during dubbing, stop the dubbing first, and upon completing the replacement, resume it. 	P87

Other

Cannot read the data on the SD memory card.	<ul style="list-style-type: none"> Make sure the SD memory card is formatted correctly. If it is not, format the card in the unit. 	P29
The remote control does not work.	<ul style="list-style-type: none"> The battery in the remote control may have run out. If the remote control fails to work even if it is operated close to the remote control sensor of the camera-recorder, it means that the battery has run out. Replace it with new one. Make sure the remote control setting is the same for the remote control unit and the camera-recorder. If the REMOTE setting is different on the remote control and the camera-recorder, the remote control will not work. 	P18 P18
There is a rattling sound when the camera-recorder is tilted back and forth.	<ul style="list-style-type: none"> There are some parts of the camera that make a rattling sound in the MCR mode or when the POWER switch is OFF. This is normal. 	—
A clicking sound is heard when the power is turned on or when the MCR mode is switched to the CAM mode.	<ul style="list-style-type: none"> This initialization operation is performed when the camera starts up. It occurs due to the construction of the camera and is not indicative of any trouble. 	—

Operating precautions

Do not allow any water to get into the camera-recorder when using it in the rain or snow or at the beach.

- Failure to heed this precaution will cause the camera-recorder or P2 card to malfunction (and may result in irreparable damage).

Keep the camera-recorder away from equipment (such as TV sets and video game machines) that generate magnetic fields.

- Using the camera-recorder on top of or near a TV set may cause distortion in the images and/or sound due to the electromagnetic waves that the set emits.
- The powerful magnetic fields generated by speakers or large motors may damage your recordings or distort the images.
- The electromagnetic waves emitted from a microcomputer will adversely affect the camerarecorder, causing the images and/or sound to be distorted.
- If the camera-recorder is so adversely affected by products that generate magnetic fields that it no longer operates properly, turn it off and remove the battery or unplug the AC adapter from the power outlet. Then install the battery again or reconnect the AC adapter. After this, turn the camera-recorder back on.

Do not use the camera-recorder near radio transmitters or high-voltage equipment.

- Using the camera-recorder near a radio transmitter or high-voltage equipment may adversely affect the recorded images and/or sound.

Do not allow any sand or dust to get into the camera-recorder when using it at the beach and other similar places.

- Sand and dust can damage the camera-recorder and P2 card. (Be especially careful when inserting or removing the P2 card.)

AC adapter and battery

- If the battery is extremely hot or cold, the CHARGE lamp will blink several times before charging starts.
- If the CHARGE lamp continues to blink even when the battery temperature is normal, there may be something wrong with the battery or AC adapter. Contact your dealer.
- The battery takes longer to charge when it is warm.

- The AC adapter can interfere with radio reception so keep radios at least 1 meter away from it.
- The AC adapter may make some noise when you are using it, but this is normal.

Take precautions not to drop the camera when moving it.

- Strong impacts may damage the camera and cause it to stop working.
- Handle the camera with care, using the hand strap or shoulder strap to carry it.

Do not spray the camera with insect sprays or other volatile substances.

- These can warp the camera or cause the finish to come off.
- Do not leave the camera-recorder in contact with rubber or PVC products for extended periods of time.

After use, remove the battery and disconnect the AC power supply cord.

Battery characteristics

This camera-recorder uses a rechargeable lithiumion battery that uses its internal chemical reaction to generate electrical energy. This reaction is easily influenced by the ambient temperature and humidity, and the battery's effective operating time is reduced as the temperature rises or falls. In very low temperatures, the battery may last only 5 minutes.

Protective circuitry functions if you use the battery where it is very hot and you will have to wait before you can use it again.

Remove the battery after use.

Completely remove the battery. (The battery continues to be used even if you have turned the camera off.) The battery can over discharge if you leave it in the camera and it may become impossible to recharge it.

Keep dust and other foreign objects away from the battery terminal.

If the battery is dropped, make sure that the body and terminal portion of the battery are not deformed.

If a deformed battery is inserted into the camera-recorder or placed on the AC adapter, the camera-recorder or AC adapter may be damaged.

What to remember when throwing memory cards away or transferring them to others

Formatting memory cards or deleting data using the functions of the unit or a computer will merely change the file management information: it will not completely erase the data on the cards. When throwing these cards away or transferring them to others, either physically destroy them or use a data deletion program for computers (commercially available) to completely erase the data. Users are responsible for managing the data on their memory cards.

Liquid crystal displays

- Images or letters can get burned onto the screen of the LCD or viewfinder if they are displayed for a long time, but you can fix this by leaving the camera off for several hours.
- The liquid crystal parts are highly precise with 99.99% of the pixels effective. This leaves less than 0.01% of pixels that may not light or may remain on all the time. These phenomena are normal and will have no effect on the images you shoot.
- Condensation may form if you use the camera where temperatures fluctuate. Wipe dry with a soft, dry cloth.
- The LCD may appear dim after immediately turning on a cold camera, but will brighten as the camera warms up.

Do not point the lens or viewfinder at the sun.

Doing so may damage the parts inside.

Protective caps for the connectors

Keep the protective caps fitted over any connectors that are not being used.

Updating the driver in the camera

For the latest information on drivers, visit the P2 Support Desk at the following Web sites.

<https://www.pavc.panasonic.co.jp/pro-av/>

To update a driver, select PROPERTY on the thumbnail menu and then SYSTEMINFO to check the camera-recorder's version, go to the site given above, and download the driver as necessary. The updating procedure is completed when the downloaded file has been loaded into the camera-recorder via the SD memory card. For further details on this procedure, go the site given above.

- For installation, you must connect the AC adapter.
- If you are going to use SD memory cards with this camera-recorder, use only cards which are in compliance with the SD standard.

Always format SD memory cards on this camera-recorder.

Cleaning

When cleaning, do not use benzene or thinner.

- Using benzene or paint thinners may deform the camera-recorder and/or cause the surface finish to peel off.
- Before proceeding with maintenance, remove the battery or disconnect the AC cord from the power outlet.
- Use a soft, clean cloth to wipe the camera-recorder. To remove stubborn dirt, wipe the camera-recorder with a cloth moistened with kitchen detergent that has been diluted with water and then use a dry cloth to take up the remaining moisture.

Cleaning the Viewfinder

- If there is dust inside the view finder, remove the eye cup holder and get rid of the dust.
- The interior of the eye cup holder is specially finished, so do not ever wipe it. If there is dust on it, blow it off with an air blower.
- Remove the eye cup holder with the eye cup attached by rotating it counterclockwise. (It will be tightly screwed on.) When you do this, tilt the view finder slightly upward.
- To amount the eye cup holder, align the ridges and grooves of the eye cup holder and camerarecorder, and turn clockwise until the holder clicks into place.

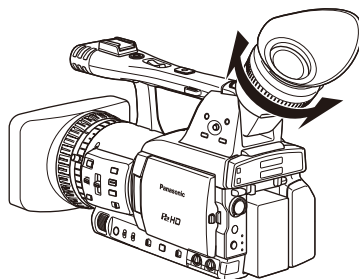
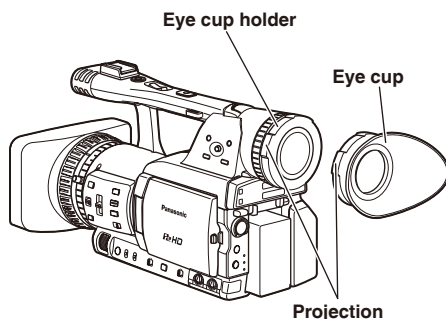

Storage Precautions

Before storing the camera-recorder, remove the battery.

Store all of these items in a place with low humidity and relatively constant temperature.

[Recommended temperature range: 15°C to 25°C]

[Recommended relative humidity: 40% to 60%]

Video camera

- Wrap the video camera in a soft cloth to keep the dust off.

Battery

- The battery life is shortened in places with extreme temperatures.
- Storing the battery in a location with oily vapors or high dust concentrations may corrode the terminals or cause other damage, leading to malfunction.
- **Keep metal objects (such as necklaces and hair pins) away from the terminals. Shortcircuiting may occur across the terminals, causing the battery to heat up, and you may seriously burn yourself if you touch the battery in this state.**
- Discharge the battery before storing it. When storing it for an extended time, charge it at least once a year, use up its charge in the camerarecorder, and then store it again.

P2 cards

- After ejecting a P2 card from the unit, be absolutely sure to attach its special cap to keep sand and dust away from the connector area. Stow the P2 cards in their own cases when storing them or carrying them around.
- Do not leave P2 cards in areas where corrosive gases, etc. are present.

SD memory cards

- After ejecting an SD memory card from the unit, be absolutely sure to stow it in its own case.
- Do not leave SD memory cards in areas where corrosive gases, etc. are present.
- Do not leave the cards inside vehicles, in places exposed to direct sunlight or in other places where the temperature is high.
- Do not leave the cards where the humidity level is high or where there are high concentrations of dust.

How to handle data recorded on P2 cards

The P2 card is a semiconductor memory card that is used as the recording medium in the professional video production and broadcasting devices that make up the DVCPRO P2 Series.

- Since data recorded in the DVCPRO P2 format are in a file format, they have excellent compatibility with PCs. The file structure is a unique format, which in addition to video and audio data in MXF files contains various other important information items. The folder structure links the data as shown on the right.

Changing or deleting just one information component could make it impossible to recognize the data as P2 data or use the card in a P2 device.



All these folders are required.

* This is the file in which the information on the final clip that was recorded with the P2 device is written.

- When transferring data from a P2 card to a PC, or when rewriting data saved on a PC to a P2 card, to prevent data loss be sure to use the special P2 Viewer software. Download it from the following website. (Compatible with the Windows XP, Windows 2000 and Windows Vista operating systems.)

<https://eww.pavc.panasonic.co.jp/pro-av/support/desk/e/index.htm>

- When using regular IT tools such as Microsoft Windows Explorer or Apple Finder to transfer data to a PC, follow the instructions below. However, be sure to use the P2 Viewer when returning data to a P2 card.
 - Transfer the corresponding CONTENTS folder and LASTCLIP.TXT file together as a set.
 - Do not transfer individual files from the CONTENTS folder.
 - When copying, copy the LASTCLIP.TXT file at the same time as the CONTENTS folder.
 - When transferring multiple P2 cards to a PC, create a folder for each P2 card to prevent clips with the same name from being overwritten.
 - Do not delete data from the P2 card.
 - Before using a P2 card, be sure to format it with a P2 device.

-
- Microsoft and Windows are registered trademarks of the Microsoft Corporation in the USA and other countries.
 - Apple and Macintosh are registered trademarks of Apple, Inc., in the USA and other countries.

Checkpoints for using memory cards

In this unit, use SD memory cards that are compatible with the SD or SDHC standard.

When using miniSD or miniSDHC cards in this unit, be sure to use the special adapter. (The unit will not operate correctly if only the adapter is inserted. Always insert a memory card into the adapter.)

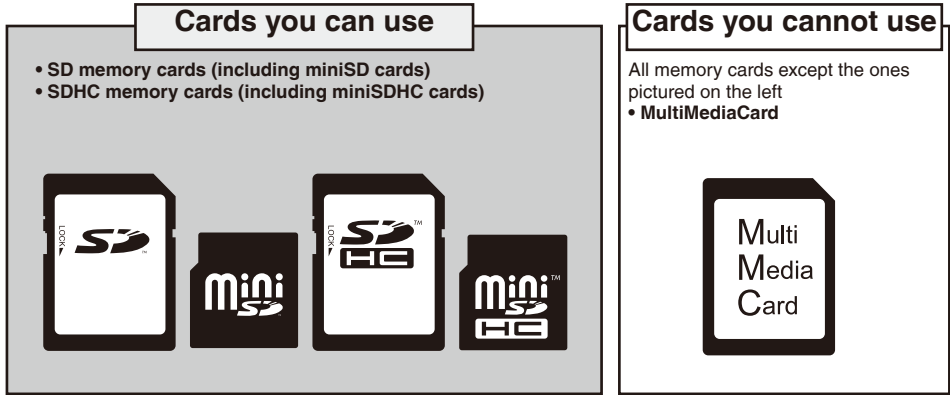

We recommend using SD/SDHC memory cards and miniSD/miniSDHC cards that are made by Panasonic.

For the latest information on the unit and on the memory cards which can be used by this unit, go to the P2 support page at the following web site:

<https://www.pavc.panasonic.co.jp/pro-av/>

-
- The SDHC card conforms to a new standard for memory cards with a large capacity of more than 2 GB which was established by the SD Association in 2006.
 - The SD card logo is a registered trademark.
 - MMC (MultiMediaCard) is a registered trademark of Infineon Technologies AG.

Recording format list

• When SYSTEM FREQ is set to 50 Hz

			Frame rate		
			50		25P
Video format	DVCPRO HD	1080i/50i	1080i/50i	1080i/25P over 50i	
		720P/50P	720P/50P	1080i/25P over 50P	
		720P/25PN	720P/50P Native recording		720P/25PN
	DVCPRO50 DVCPRO DV	576i/50i	576i/50i	576i/25P over 50i	

			Frame rate																
			12	15	18	20	21	22	23	24	25	26	27	28	30	32	34	37	42
Video format	DVCPRO HD	1080i/50i	—																
		720P/50P	720P/12P-50P over 50P																
		720P/25PN	720P/12P-50P Native recording																
	DVCPRO50 DVCPRO DV	576i/50i	—																

• When SYSTEM FREQ is set to 59.94 Hz

			Frame rate			
			60	30P	24P	24PA
Video format	DVCPRO HD	1080i/60i	1080i/60i	1080i/30P over 60i	1080i/24P over 60i	1080i/24PA over 60i
		720P/60P	720P/60P	720P/30P over 60P	720P/24P over 60P	—
		720P/30PN	720P/60P Native recording	720P/30PN	720P/24P Native recording	—
		720P/24PN	720P/60P Native recording	720P/30P Native recording	720P/24PN	—
	DVCPRO50 DVCPRO DV	480i/60i	480i/60i	480i/30P over 60i	480i/24P over 60i	480i/24PA over 60i

			Frame rate																
			12	15	18	20	21	22	24	25	26	27	28	30	32	34	36	40	44
Video format	DVCPRO HD	1080i/60i	—																
		720P/60P	720P/12P-60P over 60P																
		720P/30PN	720P/12P-60P Native recording																
		720P/24PN	720P/12P-60P Native recording																
	DVCPRO50 DVCPRO DV	480i/60i	—																

Appendix

Selecting the USER CLIP NAME recording method

Press the MENU button and select META DATA → PROPERTY → USER CLIP NAME to select the recording method. Two options are available: TYPE1 and TYPE2.

●TYPE1

	USER CLIP NAME to be recorded
If clip metadata has been read in	Uploaded data
If no clip metadata has been read in or if the setting for recording clip metadata has been turned off	Same as GLOBAL CLIP ID (UMID data)

●TYPE2

	USER CLIP NAME to be recorded
If clip metadata has been read in	Uploaded data + COUNT value*
If no clip metadata has been read in or if the setting for recording clip metadata has been turned off	Same as CLIP NAME

* The COUNT value is indicated as a four-digit number.

The COUNT value is incremented each time a new clip is captured if clip metadata has been read in and TYPE2 has been selected as the recording method.

The COUNT value can be reset using the following procedure.

Press the MENU button and select META DATA → PROPERTY → USER CLIP NAME to display the menu shown below. Select "COUNT RESET" with the cursor and press the Operation lever to reset the COUNT value to 1.

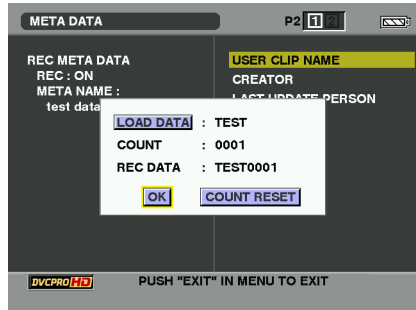

When a P2 card with a memory capacity of 8 GB or more is used in this unit and a one-time continuous recording exceeds the prescribed duration (approx. 5 minutes for DVCPRO HD, approx. 10 minutes for DVCPRO50 or DV) or when a one-time recording extends over more than one P2 card, the recording concerned will automatically be undertaken as a separate clip. At this time, each clip will be provided with its own COUNT value.

Example of recording (DVCPRO50) a clip on one P2 card:

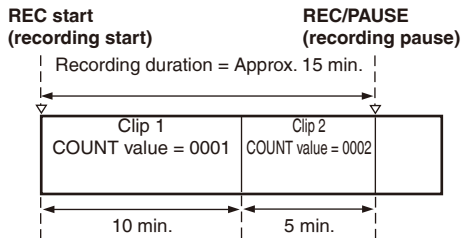

Example of recording a clip on two P2 cards:

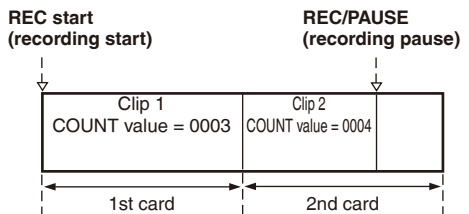

If the clip thumbnails are displayed as shown in the example above or their properties are indicated using a P2 device, the thumbnail and COUNT value of clip 1 will be displayed.

Specifications

[GENERAL]

Supply voltage: DC7.2 V/7.9 V

Power consumption

10.9 W (when the LCD monitor is not used)

11.7 W (when the LCD monitor is used)

13.8 W (max.)

 indicates safety information.

Ambient operating temperature

0 °C to 40 °C

Ambient operating humidity

10% to 85% (no condensation)

Weight

1.9 kg (excluding battery and accessories)

Dimensions (W x H x D)

154 mm x 179.5 mm x 397 mm

[Camera]

Pickup devices

CCD image sensor (x3)

(1/3-inch, interline transfer, progressive-capable)

Lens

LEICA DICOMAR Optical image stabilizer lens,

Motorized/Manual selectable 13x zoom,

F1.6 to 3.0 (f = 3.9 mm to 51 mm)

(35 mm equivalent: 28 mm to 368 mm)

Color separation optical system

Prism system

ND filter

1/4, 1/16, 1/64

Gain settings

0/+3/+6/+9/+12/+18 dB (50i/50P (60i/60P) mode)

0/+3/+6/+9/+12 dB (25P/25PN (30P/30PN/24P/
24PA/24PN) mode)

Shutter speed settings

Preset

50i/50P mode

1/50 (OFF), 1/60, 1/120, 1/250, 1/500,

1/1000, 1/2000 sec.

25P/25PN mode

1/25, 1/50 (OFF), 1/60, 1/120, 1/250, 1/500,

1/1000 sec.

60i/60P mode

1/60 (OFF), 1/100, 1/120, 1/250, 1/500,

1/1000, 1/2000 sec.

30P/30PN mode:

1/30, 1/50 (OFF), 1/60, 1/120, 1/250, 1/500,

1/1000 sec.

24P/24PA/24PN mode:

1/24, 1/50 (OFF), 1/60, 1/120, 1/250, 1/500,

1/1000 sec.

Synchro scan

50i/50P mode: 1/50.0 to 1/248.9 sec.

25P/25PN mode: 1/25 to 1/248.9 sec.

60i/60P mode: 1/60.0 to 1/249.8 sec.

30P/30PN mode: 1/30.0 to 1/249.8 sec.

24P/24PA/24PN mode: 1/24.0 to 1/249.8 sec.

Shutter opening angle

Opens in 0.5 degree increments between 10 and 360 degrees.*1

*1 When OPERATION TYPE in the SCENE FILE screen is FILM CAM.

Slow shutter speed

50i/50P mode 1/12, 1/25 sec.

25P/25PN mode 1/12 sec.

60i/60P mode: 1/15, 1/30 sec.

30P/30PN mode: 1/15 sec.

24P/24PN mode: 1/12 sec.*1

*1 Only 720/24P, 720/24PN

Minimum subject luminance

3 lx (F1.6, gain +12 dB with a shutter speed of 1/24)

Lens hood

Large-sized lens hood with wide angle of view

Filter diameter

72 mm

[VIDEO P2] (DVCPRO HD 1080i 720P)

Sampling frequency

Y: 74.25 MHz, P_B/P_R: 37.125 MHz

Quantizing

8 bit

Video compression system

DCT + variable-length code

Video compression rate

1/6.7

Video recording bit rate

100 Mbps

Specifications (continued)

[AUDIO P2] (DVCPRO HD 1080i 720P)

Sampling frequency

48 kHz

Quantizing

16 bit/4 CH

Frequency response

20 Hz to 20 kHz

[MEMORY CARD]

Video recording formats:

DVCPRO HD

1080i/50i (25P over 50i)

720P/50P (25P over 50P)

720P/25PN (Native recording)

1080i/60i (30P over 60i, 24P over 60i, 24PA over 60i)

720P/60P (30P over 60P, 24P over 60P)

720P/30PN (Native recording)

720P/24PN (Native recording)

DVCPRO50/DVCPRO/DV

576i/50i (25P over 50i)

480i/60i (30P over 60i, 24P over 60i, 24PA over 60i)

Audio recording formats:

PCM digital recording

48 kHz 16-bit 4CH (DVCPRO HD/DVCPRO50)

48 kHz 16-bit 2CH/4CH selectable (DVCPRO/DV)

Recording/playback time:

Approx. 8 minutes:

When recorded in DVCPRO HD format using one AJ-P2C008HG card with audio signals recorded on 4 channels.

Approx. 16 minutes:

When recorded in DVCPRO HD format using one AJ-P2C016RG card with audio signals recorded on 4 channels.

Approx. 32 minutes:

When recorded in DVCPRO HD format using one AJ-P2C032RG card with audio signals recorded on 4 channels.

<Note>

- This recording time represents one shot continuously recorded on a P2 card. The recording time may be shorter, depending on the number of shots recorded.
- The 720P/25PN, 720P/30PN and 720P/24PN formats are not included in the DVCPRO HD recording format.

[VIDEO OUT]

SDI output

BNC x 1, 0.8 V [p-p], 75 Ω

HD: complies with SMPTE 292M, 296M and 299M

SD: complies with SMPTE 259M-C, 272M-A, and ITU-R BT.656-4

Analog component output

Y: 1.0 V [p-p], 75 Ω

P_B/P_R: 0.7 V [p-p], 75 Ω

Analog composite output

Pin jack x 1, 1.0 V [p-p], 75 Ω

[AUDIO IN/OUT]

XLR input

XLR (3 pins) x 2 (INPUT 1, INPUT 2),

LINE/MIC selectable, high impedance

LINE: 0 dBu

MIC: -50 dBu/-60 dBu (selectable in menu)

LINE OUT

Pin jack x 2 (CH1, CH2)

Output: 316 mV, 600 Ω

Internal microphone

Stereo microphone

Headphone jack

3.5-mm stereo mini jack x 1

Internal speaker

20 mm diameter x 1

[OTHER INPUTS/OUTPUTS]

Digital interface

6 pins, digital input/output, compliant with IEEE 1394 standard

USB

Type mini B connector (compliant with USB ver. 2.0)

CAM REMOTE

Mini jack (3.5 mm diameter) (FOCUS, IRIS)

Super mini jack (2.5 mm diameter) (ZOOM S/S)

[Monitor]

LCD monitor

3.5-inch LCD color monitor, 210,000 pixels

Viewfinder

0.44-inch LCD color viewfinder, 235,000 pixels

[AC ADAPTER]**Power Source:**

100-240 V AC, 50/60 Hz 24 W

Power Output:

7.9 V DC, 1.9 A (Video Camera)

8.4 V DC, 1.2 A (Charge)



indicates safety information.

Weight

160 g

Dimensions (W x H x D)

70.0 mm x 44.5 mm x 116.0 mm

Inrush current, measured according to European standard EN55103-1: 5A

Weight and dimensions are approximate.
Specifications are subject to change without notice.

Information for Users on Collection and Disposal of Old Equipment and used Batteries



These symbols on the products, packaging, and/or accompanying documents mean that used electrical and electronic products and batteries should not be mixed with general household waste.

For proper treatment, recovery and recycling of old products and used batteries, please take them to applicable collection points, in accordance with your national legislation and the Directives 2002/96/EC and 2006/66/EC.

By disposing of these products and batteries correctly, you will help to save valuable resources and prevent any potential negative effects on human health and the environment which could otherwise arise from inappropriate waste handling.



For more information about collection and recycling of old products and batteries, please contact your local municipality, your waste disposal service or the point of sale where you purchased the items.

Penalties may be applicable for incorrect disposal of this waste, in accordance with national legislation.



For business users in the European Union

If you wish to discard electrical and electronic equipment, please contact your dealer or supplier for further information.

Cd

Information on Disposal in other Countries outside the European Union

These symbols are only valid in the European Union. If you wish to discard these items, please contact your local authorities or dealer and ask for the correct method of disposal.

Note for the battery symbol (bottom two symbol examples):

This symbol might be used in combination with a chemical symbol. In this case it complies with the requirement set by the Directive for the chemical involved.

Professional & Broadcast IT Systems Business Unit Europe
Panasonic AVC Systems Europe a Division of Panasonic Marketing Europe GmbH
Hagenauer Str. 43, 65203 Wiesbaden-Biebrich Deutschland Tel: +49-611-235-481

Panasonic Systems Asia Pacific (Broadcast Regional Operation Center)
2 Jalan Kilang Barat, Panasonic Building, Singapore 159346 Tel: +65-6270-0110

